

# THORACOSCOPY INSTRUMENTS



*GerMed*USA™

**ADDRESS:** 2417 Jericho Turnpike, #333, Garden City Park, NY 11040 (USA).

**PHONE:** 800-330-1322 | +1(516) 997-2180

**FAX:** 800-260-7177 | +1(516) 358 2182

**EMAIL:** [sales@GerMedUSA.com](mailto:sales@GerMedUSA.com)

<b>About the Company</b>	<b>2</b>
<b>Rigid and flexible Trocarsleeves</b>	<b>3</b>
<b>Hook-tip electrodes, Suction and Irrigation Tubes</b>	<b>4</b>
<b>Rotating and Detachable Instruments</b>	<b>5-8</b>
<b>Deep Suture</b>	<b>9-10</b>
<b>Speculum for Gallbladder Extraction</b>	<b>11</b>
<b>Trocarsleeves, Trocars</b>	<b>12-14</b>
<b>Reducer sleeves, Dilation Set, LAP-Accessories</b>	<b>15</b>
<b>Autoclavable Laparoscopes</b>	<b>16</b>
<b>Fiber Light Cables</b>	<b>17</b>
<b>Hook-tip Electrodes</b>	<b>18-21</b>
<b>Suction and Irrigation Tubes</b>	<b>22-23</b>
<b>Accessories for Laparoscopy / Cholezystectomy</b>	<b>24</b>
<b>Rotating and Detachable Instruments</b>	<b>25-41</b>
<b>Endo-Hook-System</b>	<b>42-44</b>
<b>Clip-Applier and Knot slider</b>	<b>45</b>
<b>Care and Cleaning</b>	<b>46</b>
<b>Handles</b>	<b>47-48</b>
<b>Detachable Forceps (Bipolar)</b>	<b>49-50</b>
<b>Graspers with Spring-Handle</b>	<b>51</b>

Special models available upon request

### ABOUT US

**GerMedUSA Inc.** is the leading manufacturer of high-quality surgical instruments worldwide. At most economical prices, we offer premium quality surgical instruments, immediately available for delivery anywhere in the world. Our broad range of surgical instruments undergoes a series of quality control testing to get excellent products. We offer a wide selection of Surgical Instruments, including; Dental Instruments, Orthopedic Surgical Instruments, Operating Room Surgical Instruments, Podiatry Surgical Instruments, Rainbow Surgical Instruments, Left Hand Instruments, Thoracoscopy, Gynecological Instruments, Dermal Instruments, Ear Instruments, Eye Instruments, Hemostatic Forceps, Cardiovascular Thoracic Instruments, Floor Grade Economy Instruments, and Tungsten Carbide Insert Needle Holders and Scissors.

**GerMedUSA Inc.** journey that began three decades ago has successfully become a symbol of Excellence, Innovation, and Reliability for veterinarians worldwide. Strictly following the **FDA** guidelines and being **ISO 13485 certified**, all our procedures are documented, and every process is being monitored at every level. We have acquired an unmatched and unique understanding of manufacturing. Our state-of-the-art manufacturing facilities and years of experience have helped us keep prices low and provide quality products. We believe more in building a strong relationship than just selling the instruments. Therefore, we enjoy providing superior customer services from the first query to the last and offer free sharpening on all our Scissors for the life of the instrument & all Dental Elevators/Luxating Elevators.

Yet, **GerMedUSA Inc.** believes that there is no end when it comes to success and perfection. Therefore, we continuously work with top-notch professionals to understand the changing market needs and future trends to develop the instruments that make them fall in love with their job. Our team of Expert Consultants is available for you whenever you need them. Order a free CD-Rom "Our electronic catalog" to save your time and deliver your order without any hassle.

Want to talk to us? Start a live chat or reach out to us via social media platforms. Or if you are looking for an instrument that we do not have, please get in touch, we will manufacture it for you.

We would love your honest feedback about what we are doing great and what improvements we need. Thanks in advance for your time and input.

### Guarantee

All our surgical instruments are guaranteed to be free from any defects in material and workmanship. Any material or instrument found to be defective will either be replaced or repaired based on the evaluation. This service is free of any cost. Our responsibility under guarantee shall be limited to only replacement and repaired policy of defective merchandise.



### Trocar sleeves

70-00505	5 mm	50 mm length	\$130.00
70-00510	10 mm	50 mm length	\$190.00
70-00513	13 mm	50 mm length	\$170.00



### Trocar with conical tip

70-01505	5 mm	\$110.00
70-1510	10 mm	\$110.00
70-01513	13 mm	\$110.00



### Trocar sleeves, flexible

70-00605	7 mm	70 mm length	\$270.00
70-00606	7 mm	100 mm length	\$270.00
70-00615	11 mm	70 mm length	\$270.00
70-00616	11 mm	100 mm length	\$270.00

### Silicone sleeve, package of 5 pcs

70-00705	7 mm	70 mm length	\$600.00
70-00706	7 mm	100 mm length	\$600.00
70-00715	11 mm	70 mm length	\$600.00
70-00716	11 mm	100 mm length	\$600.00



### Trocar

70-01605	7 mm	70 mm length	\$110.00
70-01606	7 mm	100 mm length	\$110.00
70-01615	11 mm	70 mm length	\$110.00
70-01616	11 mm	100 mm length	\$110.00



**Hook tip electrode**

blunt	70-00003	\$330.00
-------	----------	----------



**Diamond shaped cutting**

70-00006	\$340.00
----------	----------



**Dissecting Spatula, insulated**

70-00006	\$200.00
----------	----------



**Dissecting Hook, right-angled, insulated, with trumpet**

70-000014	\$400.00
-----------	----------

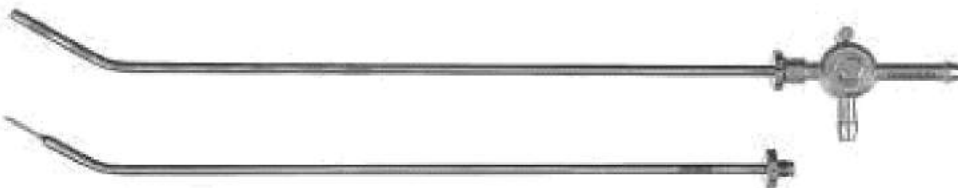

70-00600	Complete	\$580.00
<b>Suction-Irrigation tube set</b>		
consisting of:		
<b>2 Suction-Irrigation tubes</b>		
70-00601	graduated	\$90.00
70-00602	pointed	\$120.00
<b>1 Sliding valve</b>		

73-00601	Sliding valve only	\$360.00
----------	--------------------	----------

With the detachable instruments GermedUSA introduces the latest generation of Laparoscopic instruments, which can be easily disassembled for a thorough, so far not possible, cleaning. Through the unique constructional conception, it is also possible, that the interchangeable basic elements of each instrument can be combined with various handles.

In case of erosion of the instruments insert, it can be replaced by a new one. This leads to a clear lowering of costs, as only the instruments insert has to be exchanged and not the complete instrument.

The detachable GermedUSA instruments offer therefore best possible protection against infection, and they are userfriendly through a easy disassembly and the combination of the instrument inserts with various handles. As the basic elements like handle and instrument insert can be ordered separately they are cost lowering. These instruments offer a clearly improved cost-use relation.

**ASSEMBLED INSTRUMENT**

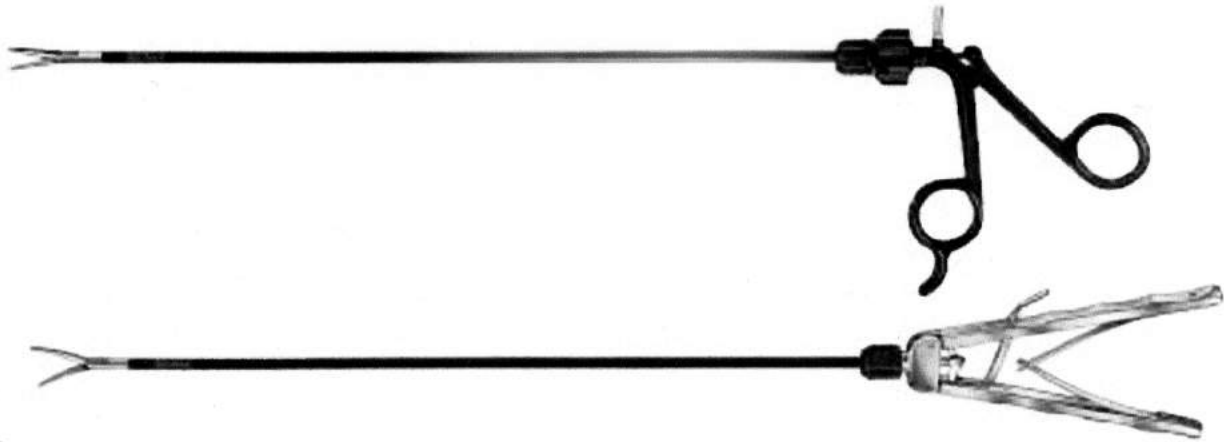

**DISASSEMBLED INSTRUMENT**

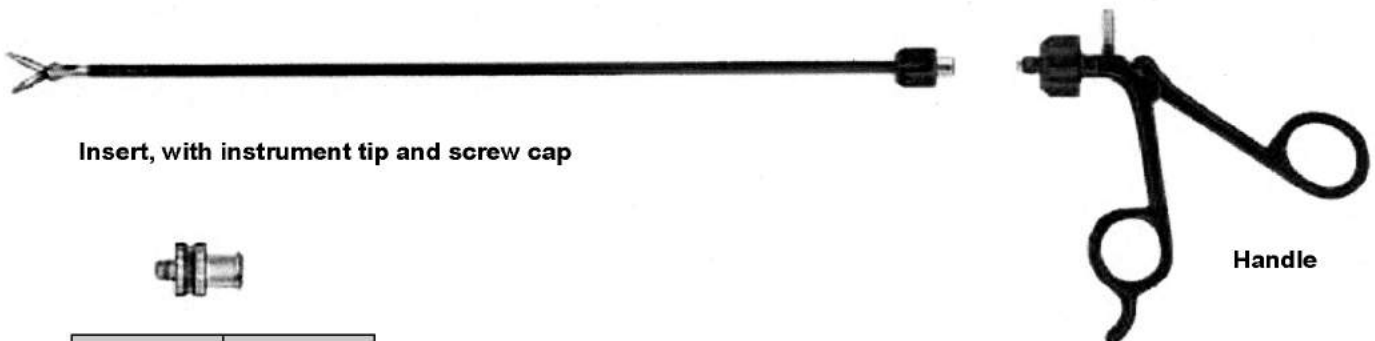

**Insert, with instrument tip and screw cap**

**Handle**

78-000-020	\$30.00	<b>Adapter for cleaning with Luer lock</b>
------------	---------	--



**monopolar unipolar**

70-082-101	Complete	\$800.00
<b>Peritoneal scissors, straight</b>		
consisting of:		
70-082-100	Insert, scissors	\$560.00
72-000-101	Handle with HF-connector	Call for code



**monopolar unipolar**

<b>METZENBAUM</b>		
70-066-101	Complete	\$800.00
<b>Peritoneal scissors, straight</b>		
consisting of:		
70-066-100	Insert, scissors	\$560.00
72-000-101	Handle with HF-connector	\$220.00



70-066-107	Complete	\$940.00
<b>Grasping forceps, delicate pattern</b>		
consisting of:		
70-066-100	Insert, grasping forceps	\$560.00
72-000-107	Handle with ratchet	Call for code



70-070-105	Complete	\$840.00
<b>Dissecting forceps, atraumatic serration</b>		
consisting of:		
70-070-100	Insert, grasping forceps	\$560.00
72-000-105	Handle with ratchet	Call for code



70-242-107	Complete	\$940.00
<b>Grasping forceps, atraumatic, De Bakey</b>		
consisting of:		
70-242-100	Insert, grasping forceps	\$600.00
72-000-101	Handle with HF-connector	\$220.00



70-076-107	Complete	\$940.00
<b>Grasping forceps 2 x 3 teeth</b>		
consisting of:		
70-076-100	Insert, grasping forceps	\$570.00
72-000-107	Handle with ratchet	Call for code



70-286-105	Complete	\$900.00
<b>Grasping forceps HI with tungsten carbide</b>		
consisting of:		
70-286-100	Insert, grasping forceps	\$600.00
72-000-105	Handle	Call for code



70-198-107	Complete	\$940.00
<b>Endo-Forceps with single De Bakey</b>		
<b>Closing protection</b>		
consisting of:		
70-198-100	Insert forceps, 35 mm jaw	\$600.00
72-000-107	Handle with ratchet	\$300.00





70-245-208	Complete	\$1,040.00
<b>Satinsky grasper, atraumatic</b>		
consisting of:		
70-245-100	Insert, grasping forceps	Call for code
72-000-200	Outer tube	\$160.00
72-000-208	Handle with ratchet	Call for code



70-250-208	Complete	\$1,200.00
<b>Lung grasper, atraumatic</b>		
consisting of:		
70-250-100	Insert, grasping forceps	Call for code
72-000-200	Outer tube	Call for code
72-000-208	Handle with ratchet	Call for code

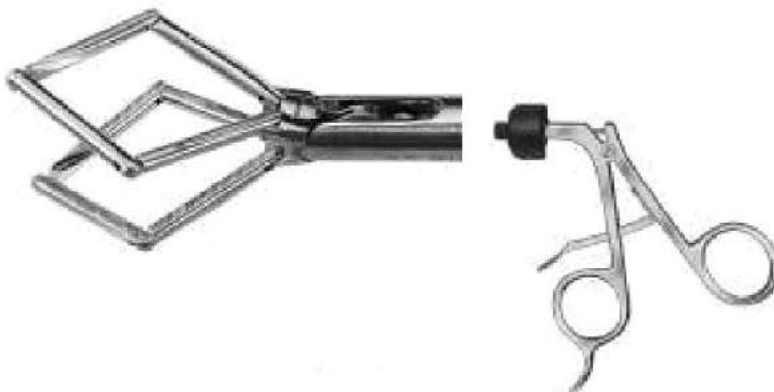

70-261-208	Complete	\$1,200.00
<b>Lung grasper, atraumatic</b>		
consisting of:		
70-261-100	Insert, grasping forceps	Call for code
72-000-200	Outer tube	Call for code
72-000-208	Handle with ratchet	Call for code

The good results of open abdominal surgery can hardly be improved upon using conventional techniques. Through the application of modern video-endoscopic technology and appropriate instruments, however, the trauma of operative access can be substantially reduced. Small punctures replace abdominal sections. The advantages of minimal invasive surgery are the results.

With a number of newly developed instruments Germed USA would like to make an up-to-date contribution to laparoscopic operating techniques.

The deep peritoneum and fascia closure of an endoscopic access involves technical problems, but is desirable in order to avoid any complications (hernia, concrescence).

With Germed USA Deep Suture, we offer you a simple, quick and sure solution. This instrument is a rod-shaped sewing device with a diameter of 12 mm which can be inserted through the endoscopic working channels without any problem. The wound channel lies tightly against the outer guide rod. The lateral needles with thread/suture are extended by turning the top control screw. By means of strong tension on the peritoneum and fascia. The thread inserted in this way is taken up and tied by hand. Thus you determine the thread tension on the tissue in the usual manner.



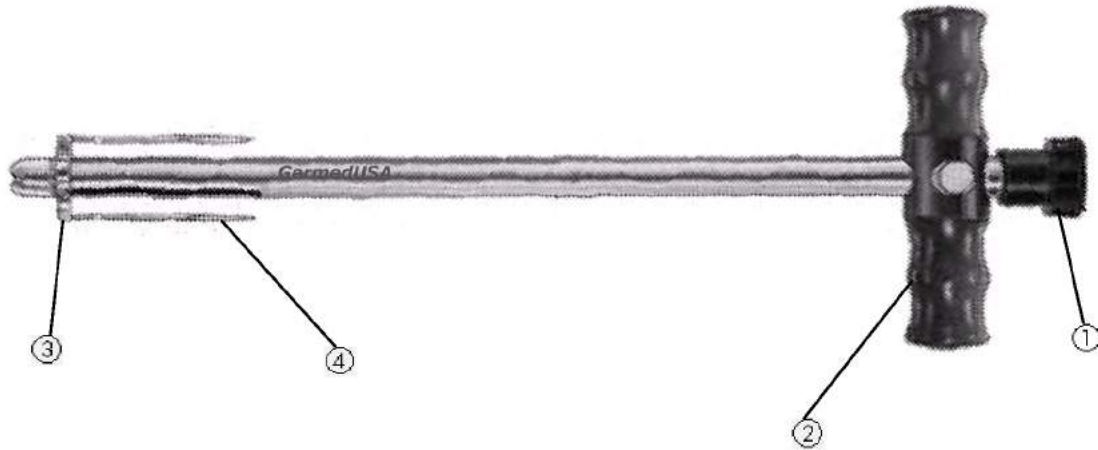

Key: Deep Suture	
①	Control screw
②	Handle
③	Lateral needle holder
④	Special needle

Technical alteration reserved.

79-00001	Deep Suture suitable for 3cm and 5cm needles	\$1,600.00
<b>1 Box = 12 pair needles</b>		
<b>Exclusive swedged-on double armed needles + suture</b>		
79-00004	3 cm needle, 60 cm suture, Polypropylene	Call for code
79-00005	5 cm needle, 60 cm suture, Polypropylene	Call for code
79-00006	3 cm needle, 60 cm suture, Chromic gut	Call for code
79-00007	5 cm needle, 60 cm suture, Chromic gut	Call for code
79-00008	12 Spare eye type needles 3 cm, for Deep Suture	Call for code
79-00009	4 Spare eye type needles 5 cm, for Deep Suture	\$100.00
79-00010	Special oil P-102 100 ml, for all instruments	\$60.00
79-00015	Needle holder with tungsten carbide	Call for code



73-00037	\$1,630.00
----------	------------

Speculum for Gallbladder extraction

### Trocar Sleeves with Trumpet Valve and Stopcock

77-00505	5 mm	\$410.00	77-00509	10.5 mm	\$470.00
77-00506	5.5 mm	\$410.00	77-00511	11 mm	\$470.00
77-00510	10 mm	\$470.00	77-00512	12.5 mm	\$470.00



### Reducer PPSU

77-00568	10 mm — 5.5 mm	\$60.00
77-00569	11 mm — 5 mm	\$60.00
77-00570	12.5 mm — 10 mm	\$60.00
77-00571	12.5 mm — 5.5 mm	\$60.00



### Trocars with Three-edged Tip, suitable for metal (and plastic) Trocar Sleeves

77-01505	5 mm	\$100.00	77-01509	10.5 mm	\$100.00
77-01506	5.5 mm	\$100.00	77-01511	11 mm	\$100.00
77-01510	10 mm	\$100.00	77-01513	12.5 mm	\$100.00



### Trocars with Conical Tip

77-02505	5 mm	\$100.00	77-02509	10.5 mm	\$100.00
77-02506	5.5 mm	\$100.00	77-02511	11 mm	\$100.00
77-02510	10 mm	\$100.00	77-02513	12.5 mm	\$100.00



### Reuseable Safety Trocar (3-edged grinding)

77-01025	5 mm	\$700.00	77-01031	11 mm	\$700.00
77-01026	5.5 mm	\$700.00	77-01032	12.5 mm	\$700.00
77-01030	10 mm	\$700.00			



## Trocar Sleeves with Trumpet Valve

77-00615	15 mm	\$600.00
77-00620	20 mm	\$600.00



## Trocars with Three-edged Tip

77-01515	15 mm	\$110.00
77-01520	20 mm	\$110.00



## Trocars with Conical Tip

77-02515	15 mm	\$100.00
77-02520	20 mm	\$100.00



## Spare Parts for Trocar Sleeve

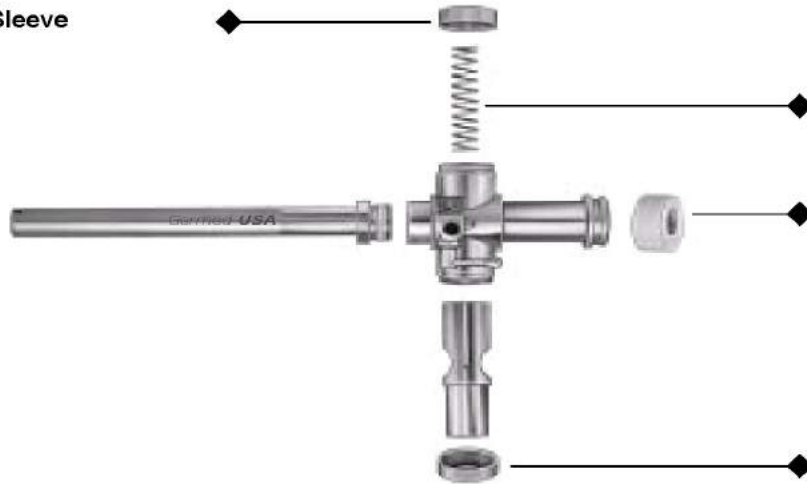

Trocar sizes	Valve cap, closed		Spring		Sealing cap, 10 pieces		Valve cap, open	
5 mm	77-00600	\$30.00	77-00610	\$10.00	77-00620	\$60.00	77-00630	\$30.00
5.5 mm	77-00601	\$30.00	77-00611	\$10.00	77-00621	\$60.00	77-00631	\$30.00
10 mm	77-00602	\$30.00	77-00612	\$10.00	77-00622	\$60.00	77-00632	\$30.00
10.5 mm	77-00603	\$40.00	77-00613	\$10.00	77-00623	\$60.00	77-00633	\$30.00
11 mm	77-00604	\$40.00	77-00614	\$16.00	77-00624	\$60.00	77-00634	\$30.00
12.5 mm	77-00605	\$30.00	77-00615	\$16.00	77-00625	\$60.00	77-00635	\$30.00
15 mm	77-00606	\$40.00	77-00616	\$16.00	77-00626	\$70.00	77-00636	\$50.00
20 mm	77-00607	\$40.00	77-00617	\$16.00	77-00627	\$70.00	77-00637	\$50.00

## Trocar Sleeves with stopcock and folding valve

77-00635	5 mm	\$470.00
77-00636	5.5 mm	\$470.00
77-00640	10 mm	\$490.00
77-00641	11 mm	\$500.00
77-00642	12.5 mm	\$500.00



## Automatic Trocar Sleeve with manual Trap Door

77-00735	5 mm	\$540.00
77-00736	5.5 mm	\$540.00
77-00740	10 mm	\$570.00
77-00741	11 mm	\$570.00
77-00742	12.5 mm	\$600.00



## Spare Parts for Trocar Sleeves



Trocar sizes	◆ Sealing ring, 10 pieces		◆ Sealing ring, 10 pieces		◆ Screw cap		◆ Sealing cap, 10 pieces
5 mm	77-00670		77-00675		77-00678		77-00684
5.5 mm	77-00670		77-00675		77-00678		77-00685
10 mm	77-00671		77-00676		77-00679		77-00686
10.5 mm	77-00671		77-00676		77-00679		77-00687
11 mm	77-00671		77-00676		77-00679		77-00688
12.5 mm	77-00671		77-00676		77-00679		77-00689



**Reducer Sleeve**

**Trocar-Stop**



77-00103	10 mm —5 mm		77-00113	15 mm —10 mm	\$90.00
77-00104	11 mm —5 mm		77-00114	15 mm —11 mm	\$90.00
77-00106	12.5 mm — 5 mm		77-00116	20 mm —5 mm	\$100.00
77-00108	12.5 mm —10 mm		77-00118	20 mm —10 mm	\$100.00
77-00110	15 mm —5 mm		77-00120	20 mm —11 mm	\$100.00

77-00090	5 mm	\$60.00	77-00093	10.5 mm	\$120.00
77-00091	6.5 mm	\$60.00	77-00094	11 mm	\$120.00
77-00092	10 mm	\$60.00	77-00095	12.5 mm	\$120.00



**Dilation Sets, consisting of dilation rod and dilation sleeve**

77-00132	5 mm —10 mm	\$210.00	70-00146	10 mm —20 mm	\$210.00
77-00140	5 mm —15 mm	\$210.00	70-00148	11 mm —15 mm	\$220.00
77-00142	5 mm — 20 mm	\$210.00	70-00150	10 mm —20 mm	\$220.00
77-00144	10 mm —15 mm	\$210.00			



**Insufflation Needle acc. To Veress**

77-00160	2.00 x 100 mm	\$100.00
77-00162	2.00 x 120 mm	\$100.00
77-00164	2.00 x 140 mm	\$100.00
77-00165	2.00 x 150 mm	\$110.00
77-00170	2.00 x 200 mm	\$110.00



**Palpation probe graduated**

77-03510	330 mm	5 mm	\$80.00
77-03511	450 mm	5mm	\$90.00



All telescopes are equipped with a 3-way variable cable connector to connect the following systems:

**ACM, BRITISH, WOLF, HSW, STORTZ, OLYMPUS**



**Optics for laparoscopy  
autoclavable at 2, 3 bar (134°C)**

71-00010	5 mm	direct vision	0°	\$5,030.00
71-00020	5 mm	foroblique	30°	\$5,180.00
71-00030	10 mm	direct vision	0°	\$4,750.00
71-00040	10 mm	foroblique	30°	\$4,890.00
71-00050	10mm	direct vision	45°	\$5,800.00



**Sterilizable Optic Heater protects the optics  
outside of the OP-field of loss of heat**

71-00100	for 5 mm Optics	\$90.00
71-00110	for 10 mm Optics	\$90.00



**Fiber Light Cables, Autoclavable at 2 bar (134°C)**

Endoskop-Adapter		180 length		230 length		300 length	
Rema / Storz	4.8	71-00200	\$450.00	71-00210	\$440.00	71-00220	\$700.00
	6.0	71-00201	\$450.00	71-00211	\$1,150.00	71-00221	\$1,310.00
Winter / Ibe	4.8	71-00202	\$560.00	71-00212	\$660.00	71-00222	\$790.00
	6.0	71-00203	\$950.00	71-00213	\$1,170.00	71-00223	\$1,320.00
Wolf / HSW	4.8	71-00204	\$570.00	71-00214	\$690.00	71-00224	\$800.00
	6.0	71-00205	\$960.00	71-00215	\$1,150.00	71-00225	\$1,330.00
ACM / British	4.8	71-00206	\$550.00	71-00216	\$690.00	71-00226	\$800.00
	6.0	71-00207	\$960.00	71-00217	\$1,150.00	71-00227	\$1,330.00

**angle connection for projector side**

71-00300	\$90.00
----------	---------

**Type A**



**Type B**



**HF Connection Cables**

72-00000	Type A	3.50 m Length	\$100.00
72-00500	Type B	3.50 m Length	\$100.00

Hook-tip electrodes insulated up to the front,  
To the maximum extent

Type A



Type B



Blunt	Type A		Type B	
Length 330 mm	72-00001	\$250.00	72-00601	\$250.00
Length 450 mm	72-00101	\$260.00	72-00601	\$260.00



Diamond Shaped Cutting Surface	Type A		Type B	
Length 330 mm	72-00002	\$250.00	72-00602	\$250.00
Length 450 mm	72-00102	\$260.00	72-00602	\$260.00



Blunt	Type A		Type B	
Length 330 mm	72-00003	\$250.00	72-00603	\$250.00
Length 450 mm	72-00103	\$260.00	72-00603	\$260.00



Diamond Shaped Cutting Surface	Type A		Type B	
Length 330 mm	72-00004	\$250.00	72-00604	\$250.00
Length 450 mm	72-00104	\$260.00	72-00604	\$260.00



Diamond Shaped Cutting Surface	Type A		Type B	
Length 330 mm	72-00005	\$250.00	72-00605	\$250.00
Length 450 mm	72-00105	\$260.00	72-00605	\$260.00

Hook-tip electrodes insulated up to the front,  
To the maximum extent, as well as on the back up to the tip

Type A



Type B



Blunt Curved	Type A		Type B	
Length 330 mm	72-00011	\$280.00	72-00611	\$280.00
Length 450 mm	72-00111	\$290.00	72-00611	\$290.00



Diamond Shaped Cutting Surface	Type A		Type B	
Length 330 mm	72-00012	\$300.00	72-00612	\$300.00
Length 450 mm	72-00112	\$310.00	72-00612	\$310.00



Blunt	Type A		Type B	
Length 330 mm	72-00013	\$290.00	72-00613	\$290.00
Length 450 mm	72-00113	\$300.00	72-00613	\$300.00



Diamond Shaped Cutting Surface	Type A		Type B	
Length 330 mm	72-00014	\$300.00	72-00614	\$300.00
Length 450 mm	72-00114	\$310.00	72-00614	\$310.00



Diamond Shaped Cutting Surface	Type A		Type B	
Length 330 mm	72-00015	\$300.00	72-00615	\$290.00
Length 450 mm	72-00115	\$310.00	72-00615	\$310.00

**Type A**



**Type B**



Button Tip Electrode	Type A		Type B	
Length 300 mm	72-00020	\$170.00	72-00620	\$240.00
Length 450 mm	72-00120	\$200.00	72-00620	\$250.00



Cone Tip Electrode	Type A		Type B	
Length 300 mm	72-00021	\$170.00	72-00621	\$240.00
Length 450 mm	72-00121	\$260.00	72-00621	\$250.00



Knife Tip Electrode	Type A		Type B	
Length 300 mm	72-00022	\$180.00	72-00622	\$260.00
Length 450 mm	72-00122	\$250.00	72-00622	\$290.00



Loop Tip Electrode	Type A		Type B	
Length 300 mm	72-00023	\$170.00	72-00623	\$240.00
Length 450 mm	72-00123	\$260.00	72-00623	\$250.00



**Coagulation and suction-cannula, insulated, with trumpet valve**

73-00001	\$280.00
----------	----------



**Dissecting Spatula, insulated, with trumpet valve and suction**

73-00002	\$280.00
----------	----------



**Dissecting Hook, insulated, with trumpet valve and suction**

73-00003	\$280.00
----------	----------



**Dissecting Hook, right-angled, insulated, with trumpet valve and suction**

73-00004	\$300.00
----------	----------



**Coagulation and suction-cannula, insulated**

73-00011	\$160.00
----------	----------



**Dissecting Spatula, insulated, with suction**

73-00012	\$160.00
----------	----------



**Dissecting Hook, insulated, with suction**

73-00013	\$160.00
----------	----------



**Dissecting Hook, right-angled, insulated, with suction**

73-00014	\$160.00
----------	----------

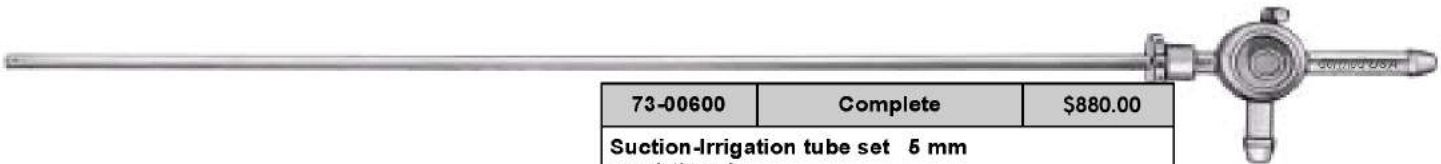

<b>73-00600</b>	<b>Complete</b>	<b>\$880.00</b>
<b>Suction-Irrigation tube set 5 mm</b> consisting of:		
7 Suction-Irrigation tubes Fig. 1 to 7		
1 Sliding Valve		
<b>73-00601</b>	<b>Sliding valve only</b>	<b>\$360.00</b>

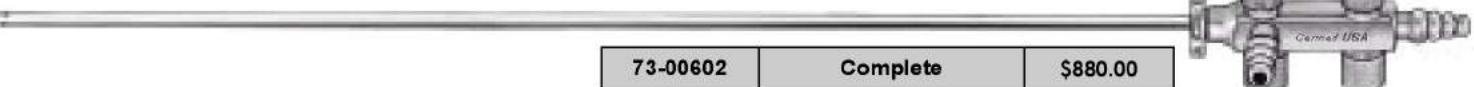

<b>73-00602</b>	<b>Complete</b>	<b>\$880.00</b>
<b>Suction-Irrigation tube set 5 mm</b> consisting of:		
7 Suction-Irrigation tubes Fig. 1 to 7		
1 Trumpet Valve		
<b>73-00603</b>	<b>Trumpet valve only</b>	<b>\$380.00</b>



<b>Suction-Irrigation tube</b>	
<b>73-00610</b>	<b>\$70.00</b>



<b>Suction-Irrigation tube</b>	
<b>73-00611</b>	<b>\$70.00</b>



<b>Suction-Irrigation tube</b>	
<b>73-00612</b>	<b>\$70.00</b>



<b>Suction-Irrigation tube</b>	
<b>73-00614</b>	<b>\$70.00</b>



<b>Suction-Irrigation tube</b>	
<b>73-00615</b>	<b>\$90.00</b>



<b>Suction-Irrigation tube</b>	
<b>73-00616</b>	<b>\$90.00</b>

see above,  
but 500mm

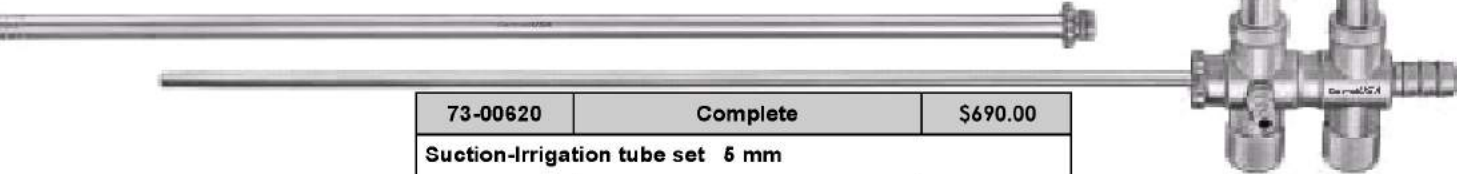

<b>73-00620</b>	<b>Complete</b>	<b>\$690.00</b>
<b>Suction-Irrigation tube set 5 mm</b>		
<b>73-00621</b>	<b>Suction-Irrigation tube 5 mm</b>	<b>\$70.00</b>
<b>73-00622</b>	<b>Suction-Irrigation tube 10 mm</b>	<b>\$70.00</b>
<b>73-00623</b>	<b>Trumpet valve</b>	<b>\$620.00</b>



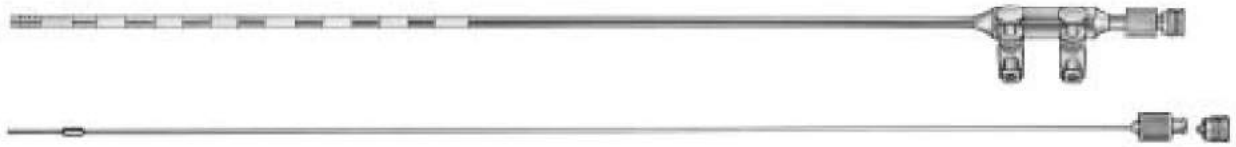

73-00008	\$320.00
----------	----------

**Suction and Irrigation tube, with central tube laser fiber**



73-00005	\$360.00
----------	----------

**Suction and Irrigation tube, with central tube laser fiber**



73-00006	\$140.00
----------	----------

**Suction tube with stop cock, Luer Lock**



73-00007	\$290.00
----------	----------

**Suction and Irrigation tube with two trumpet valves**



73-00015	6 mm	\$20.00
73-00016	8 mm	\$20.00
<b>connector, Luer Lock</b>		
<b>(female)</b>		



73-00017	6 mm	\$20.00
73-00018	8 mm	\$20.00
<b>connector, Luer Lock</b>		
<b>(male)</b>		





73-00039	\$1,050.00
----------	------------

**Cholangiographie Fixation forceps**



73-00041	\$80.00
----------	---------

**Injection and puncture needle, LuerLock**



73-00042	\$200.00
----------	----------

**Two-way stopcock for contrast medium**



73-00043	\$80.00
----------	---------

**Guide tube for Cholangiocatheter**



73-00044	\$70.00
----------	---------

**Guide hook for Cholangiocatheter**

### **GermedUSA Inc.**

#### **INSTRUMENT LINE - easy change**















The following benefits offers the newest *GermedUSA* Laparoscopy instrument line "easy change".

- Ergonomic light design, excellent cleaning quality e.g. fast, effective and simple. Every instrument features additionally extra fast cleaning possibility via "Luer Lock".
- Very easy and simple handling as handle can be removed by pressing with one finger, this corresponds to a quick lock as no screws are used any longer.
- For handles with ratchet we developed a new comfortable ratchet design with easy handling. The users finger posture is the same like holding a handle without ratchet.

The handicap through the traditional ratchet on the handle is cancelled.















"Easy change line" is in 5mm and in 10mm available. **NEW!!** For 5mm inserts as well as for the 10mm you use the same handle. All instruments are 360 rotatable and auto-clavable. Can be taken apart fast and easily into 3 parts: handle, outer tube and working insert.



5 mm	Working Length	Handle 75-000-101	Handle 75-000-103	Handle 75-000-105	Handle 75-000-107	Handle 75-000-147
	330 mm					
	430 mm					
	<b>Hook scissors, straight</b>					
	75-051-000		75-051-101			
	76-051-000		76-051-101			
	<b>Peritoneal scissors, straight</b>					
	75-082-000		75-082-101			
	76-082-000		76-082-101			
	<b>Micro dissecting scissors, straight</b>					
	75-048-000		75-048-101		75-048-105	
	<b>Micro dissecting scissors, curved left</b>					
	75-049-000		75-049-101		75-049-105	
	<b>METZENBAUM, Dissecting scissors, short, curved</b>					
	75-047-000		75-047-101			
	<b>METZENBAUM, Dissecting scissors, straight</b>					
	75-054-000		75-054-101			
	76-054-000		76-054-101			
	<b>METZENBAUM, Dissecting scissors, curved</b>					
	75-056-000		75-056-101			
	76-056-000		76-056-101			
	<b>Biopsy forceps</b>					
	75-063-000		75-063-101			
	76-063-000		76-063-101			
	<b>Biopsy forceps with thorn</b>					
	75-064-000		75-064-101			
	76-064-000		76-064-101			















Outer Tube 330 mm 75-000-100 5mm  
430 mm 76-000-100 5mm



<b>5 mm</b>	Working Length	Handle 75-000-101	Handle 75-000-103	Handle 75-000-105	Handle 75-000-107	Handle 75-000-147
	330 mm					
	430 mm					
	<b>BLAKESLY, Biopsy forceps</b>					
	75-081-000		75-081-101			
	76-081-000		76-081-101			
	<b>Biopsy punch</b>					
	75-060-000		75-060-101			
	76-060-000		76-060-101			
	<b>Biopsy punch</b>					
	75-062-000		75-062-101			
	76-062-000		76-062-101			
	<b>Grasping forceps</b>					
	75-065-000		75-065-101		75-065-103	
	76-065-000		76-065-101		76-065-103	
	<b>Grasping forceps Fenestrated</b>					
	75-079-000		75-079-103			
	76-079-000		76-079-103			
	<b>Grasping forceps, delicate pattern</b>					
	75-066-000		75-066-103			
	76-066-000		76-066-103			
	<b>Grasping forceps, heavy pattern</b>					
	75-078-000		75-078-103			
	76-078-000		76-078-103			
	<b>Grasping forceps</b>					
	75-068-000		75-068-103			
	76-068-000		76-068-103			
	<b>Grasping forceps, pointed</b>					
	75-069-000		75-069-103			
	76-069-000		76-069-103			

Outer Tube    330 mm    75-000-100    5mm  
 430 mm    76-000-100    5mm



5 mm	Working Length	Handle 75-000-101	Handle 75-000-103	Handle 75-000-105	Handle 75-000-107	Handle 75-000-147
	330 mm					
	430 mm					
	<b>Grasping forceps</b>					
	75-075-000		75-075-103			
	76-075-000		76-075-103			
	<b>Dissecting forceps, atraumatic serration</b>					
	75-070-000		75-070-101		75-070-103	
	76-070-000		76-070-101		76-070-103	
	<b>MARYLAND, Dissecting forceps, curved</b>					
	75-072-000		75-072-101			
	76-072-000		76-072-101			
	<b>Dissecting forceps, curved 45</b>					
	75-246-000		75-246-101		75-246-105	
	76-246-000		76-246-101		76-246-105	
	<b>Dissecting forceps, curved 90</b>					
	75-247-000		75-247-101		75-247-105	
	<b>Grasping forceps, atraumatic, De Bakey</b>					
	75-242-000		75-242-103		75-242-107	
	76-242-000		76-242-103		76-242-107	
	<b>Grasping forceps</b>					
	75-077-000		75-077-103			
	76-077-000		76-077-103			
	<b>Grasping forceps 2x3 teeth</b>					
	75-076-000		75-076-103			
	76-076-000		76-076-103			
	<b>Claw forceps 2x3 teeth</b>					
	75-083-000		75-083-103		75-083-107	





Outer Tube 330 mm 75-000-100 5mm  
430 mm 76-000-100 5mm



5 mm	Working Length	Handle 75-000-101	Handle 75-000-103	Handle 75-000-105	Handle 75-000-107	Handle 75-000-147
	330 mm					
	430 mm					
	<b>Grasping forceps HI with tungsten carbide</b>					
	75-286-000		75-286-103		75-286-107	
	76-286-000		76-286-103		76-286-107	
	<b>ALLIS, Grasping forceps</b>					
	75-105-000		75-105-103		75-105-107	
	<b>ALLIS, Grasping forceps, atraumatic, De Bakey</b>					
	75-111-000		75-111-103		75-111-107	
	<b>Endo-Forceps with single De Bakey, closing protection</b>					
	75-198-000		75-198-103		75-198-107	
	<b>KOCHER, Grasping forceps, atraumatic, De Bakey</b>					
	75-171-000		75-171-103		75-171-107	
	<b>Endo-Lung Palpation forceps</b>					
	75-233-000		75-233-101		75-233-105	
	<b>Dissecting forceps 90 curved, using with 12,5 mm trocar sleeve</b>					
	75-067-000		75-067-101		75-067-105	
	<b>Needle holder with tungsten carbide inserts 8 mm</b>					
	75-201-000		75-201-107		75-201-147	
	<b>Suture fixation forceps, U-shaped jaws</b>					
	75-248-000		75-248-107		75-248-147	







Outer Tube 330 mm 75-000-100 5mm  
 430 mm 76-000-100 5mm



<p><b>10 mm</b></p> 	<p>Working Length</p> <p><b>330 mm</b></p>	<p>Handle 75-000-201</p> 	<p>Handle 75-000-203</p> 	<p>Handle 75-000-205</p> 	<p>Handle 75-000-207</p> 	
	<p><b>Operating scissors, large</b></p> <p>75-084-000</p>		<p>75-084-201</p>		<p>75-084-205</p>	
	<p><b>Spoon forceps, large</b></p> <p>75-180-000</p>		<p>75-180-203</p>		<p>75-180-207</p>	
	<p><b>Claw forceps 2x3 teeth</b></p> <p>75-179-000</p>		<p>75-179-203</p>		<p>75-179-207</p>	
	<p><b>Grasping forceps, heavy pattern</b></p> <p>75-225-000</p>		<p>75-225-203</p>		<p>75-225-207</p>	
<p><b>MARYLAND, Dissecting forceps, curved</b></p> <p>75-074-000</p>		<p>75-074-201</p>		<p>75-074-203</p>		
<p><b>ALLIS, Grasping forceps</b></p> <p>75-101-000</p>		<p>75-101-203</p>		<p>75-101-207</p>		
<p><b>ALLIS, Grasping forceps, atraumatic, De Bakey</b></p> <p>75-108-000</p>		<p>75-108-203</p>		<p>75-108-207</p>		
<p><b>BABCOCK, Grasping forceps</b></p> <p>75-120-000</p>		<p>75-120-203</p>		<p>75-120-207</p>		
<p><b>BABCOCK, Grasping forceps, atraumatic, De Bakey</b></p> <p>75-123-000</p>		<p>75-123-203</p>		<p>75-123-207</p>		

Outer Tube 330 mm 75-000-200 10mm













<p><b>10 mm</b></p>	<p>Working Length</p> <p><b>330 mm</b></p>	<p>Handle 75-000-201</p> 	<p>Handle 75-000-203</p> 	<p>Handle 75-000-205</p> 	<p>Handle 75-000-207</p> 	
	<p><b>DUVAL, Grasping forceps</b></p> <p>75-176-000      75-176-203      75-176-207</p>					
	<p><b>COLLIN, Grasping forceps, atraumatic</b></p> <p>75-181-000      75-181-203      75-181-207</p>					
	<p><b>Dissecting-Grasping forceps, atraumatic, DeBakey</b></p> <p>75-080-000      75-080-201      75-080-203</p>					

Outer Tube    **330 mm 75-000-200 10mm**





<b>10 mm</b>	Jaw Length	Working Length	Handle 75-000-201	Handle 75-000-203	Handle 75-000-205	Handle 75-000-207
	Diameter	330 mm				
	<b>KOCHER, Grasping forceps, atraumatic</b>					
	50MM / 10MM	75-132-000		75-132-203		75-132-207
	60MM / 10MM	75-135-000		75-135-203		75-135-207
	<b>KOCHER, Grasping forceps, atraumatic, single DeBakey</b>					
	50MM / 10MM	75-147-000		75-147-203		75-147-207
	60MM / 10MM	75-150-000		75-150-203		75-150-207
	<b>KOCHER, Grasping forceps, atraumatic, double DeBakey</b>					
	50MM / 10MM	75-162-000		75-162-203		75-162-207
	60MM / 10MM	75-165-000		75-165-203		75-165-207
	<b>Endo-Forceps with single DeBakey, closing protection</b>					
	50MM / 10MM	75-196-000		75-196-203		75-196-207
	60MM / 10MM	75-197-000		75-197-203		75-196-207
	<b>Endo-Forceps with double DeBakey, closing protection</b>					
	50MM / 10MM	75-192-000		75-192-203		75-192-207
	60MM / 10MM	75-193-000		75-193-203		75-192-207
	<b>Endo-Lung Palpation forceps</b>					
	50MM / 10MM	75-231-000		75-231-203		75-231-207
	60MM / 10MM	75-232-000		75-232-203		75-231-207

Outer Tube 330 mm 75-000-200 10mm



With the detachable instruments *Germed USA* introduces the latest generation of laparoscopic instruments, which can be easily disassembled for a thorough, so far not possible, cleaning. Through the unique constructional conception, it is also possible, that the interchangeable basic elements of each instrument can be combined with various handles.

In case of erosion of the instruments' insert, it can be replaced by a new one. This leads to a clear lowering of costs, as only the instruments insert has to be exchanged and not the complete instrument.









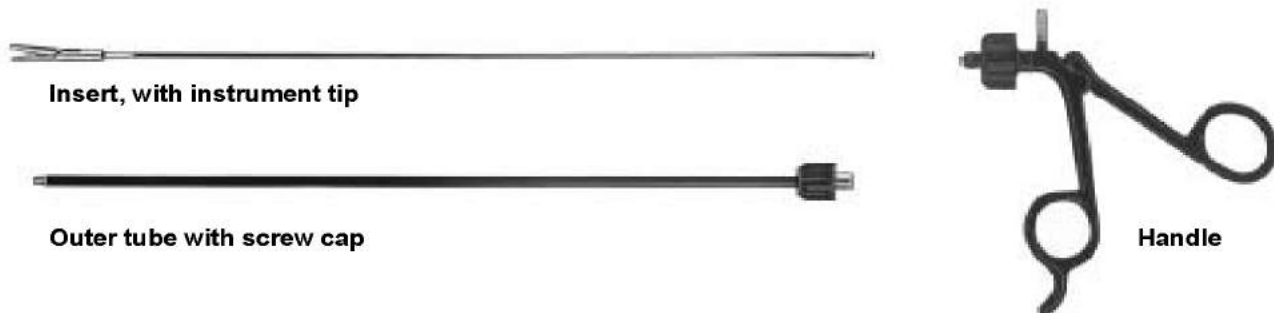





The detachable *Germed USA* instruments offer therefore best possible protection against infection, and they are user-friendly through an easy disassembly and the combination of the instrument inserts with various handles. As the basic elements like handle and instrument insert can be ordered separately they are cost lowering. These instruments offer a clearly improved cost-use relation.

### ASSEMBLED INSTRUMENT

















### DISASSEMBLED INSTRUMENT



5 mm	Working Length	Handle 72-000-101	Handle 72-000-103	Handle 72-000-105	Handle 72-000-107	Handle 72-000-147
	330 mm					
	430 mm					
	<b>Hook scissors, straight</b>					
	72-051-000		72-051-101			
	74-051-000		72-051-101			
	<b>Hook scissors, curved left</b>					
	72-053-000		72-053-101			
	<b>Peritoneal scissors, straight</b>					
	72-082-000		72-082-101			
	74-082-000		74-082-101			
	<b>Micro dissecting scissors, straight</b>					
	72-048-000		72-048-101		72-048-105	
	<b>Micro dissecting scissors, curved left</b>					
	72-049-000		72-049-101		72-049-105	
	<b>METZENBAUM, Dissecting scissors, straight</b>					
	72-046-000		72-046-101			
	<b>METZENBAUM, Dissecting scissors, curved</b>					
	72-047-000		72-047-101			
	<b>METZENBAUM, Dissecting scissors, straight</b>					
	72-054-000		72-054-101			
	74-054-000		74-054-101			
	<b>METZENBAUM, Dissecting scissors, curved</b>					
	72-056-000		72-056-101			
	74-056-000		74-056-101			

Outer Tube 330 mm 72-000-100 5mm  
430 mm 74-000-100 5mm



5 mm	Working Length	Handle 72-000-101	Handle 72-000-103	Handle 72-000-105	Handle 72-000-107	Handle 72-000-147
	330 mm					
	430 mm					
	<b>METZENBAUM, Dissecting scissors, straight, with teeth</b>					
	72-057-000	72-057-101				
	74-057-000	74-057-101				
	<b>METZENBAUM, Dissecting scissors, curved, with teeth</b>					
	72-059-000	72-059-101				
	74-059-000	74-059-101				
	<b>Biopsy forceps</b>					
	72-063-000	72-063-101				
	74-063-000	74-063-101				
	<b>Biopsy forceps with thorn</b>					
	72-064-000	72-064-101				
	74-064-000	74-064-101				
	<b>BLAKESLY, Biopsy forceps</b>					
	72-081-000	72-081-101				
	74-081-000	74-081-101				
	<b>Biopsy punch</b>					
	72-060-000	72-060-101				
	74-060-000	74-060-101				
	<b>Biopsy punch</b>					
	72-062-000	72-062-101				
	74-062-000	74-062-101				
	<b>Grasping forceps</b>					
	72-065-000		72-065-103			
	74-065-000		72-065-103			
	<b>Grasping forceps, fenestrated</b>					
	72-079-000		72-079-103			
	74-079-000		74-079-103			















Outer Tube 330 mm 72-000-100 5mm  
430 mm 74-000-100 5mm



5 mm	Working Length	Handle 72-000-101	Handle 72-000-103	Handle 72-000-105	Handle 72-000-107	Handle 72-000-147
	330 mm					
	430 mm					
	<b>Grasping forceps, delicate pattern</b>					
	72-066-000		72-066-103			
	74-066-000		74-066-103			
	<b>Grasping forceps, heavy pattern</b>					
	72-078-000		72-078-103			
	74-078-000		74-078-103			
	<b>Grasping forceps</b>					
	72-068-000		72-068-103			
	74-068-000		74-068-103			
	<b>Grasping forceps, pointed</b>					
	72-069-000		72-069-103			
	74-069-000		74-069-103			
	<b>Grasping forceps</b>					
	72-075-000		72-075-103			
	74-075-000		74-075-103			
	<b>Dissecting forceps, atraumatic serration</b>					
	72-070-000		72-070-101			
	74-070-000		74-070-101			
	<b>MARYLAND, Dissecting forceps, curved</b>					
	72-072-000		72-072-101			
	74-072-000		74-072-101			
	<b>Dissecting forceps, curved 45</b>					
	72-246-000		72-246-101		72-246-105	
	74-246-000		74-246-101		74-246-105	
	<b>Dissecting forceps, curved 90</b>					
	72-247-000		72-247-101		72-247-105	

Outer Tube 330 mm 72-000-100 5mm  
430 mm 74-000-100 5mm



5 mm	Working Length	Handle 72-000-101	Handle 72-000-103	Handle 72-000-105	Handle 72-000-107	Handle 72-000-147
	330 mm					
	430 mm					
	<b>Grasping forceps, atraumatic, De Bakey, with tungsten carbide</b>					
	72-240-000		72-240-103		72-240-107	
	<b>Grasping forceps, atraumatic, De Bakey</b>					
	72-242-000		72-242-103		72-242-107	
	74-242-000		74-242-103		74-242-107	
	<b>Grasping forceps</b>					
	72-077-000		72-077-103			
	74-077-000		74-077-103			
	<b>Grasping forceps 2x3 teeth</b>					
	72-076-000		72-076-103			
	74-076-000		74-076-103			
	<b>Claw forceps 2x3 teeth</b>					
	72-083-000		72-083-103		72-083-107	
	<b>DORSEY, Grasping forceps</b>					
	72-249-000		72-249-103		72-249-107	
	<b>Grasping forceps HI with tungsten carbide</b>					
	72-286-000		72-286-103		72-286-107	
	74-286-000		74-286-103		74-286-107	
	<b>ALLIS, Grasping forceps</b>					
	72-105-000		72-105-103		72-105-107	
	<b>ALLIS, grasping forceps, atraumatic, De Bakey</b>					
	72-111-000		72-111-103		72-111-107	













Outer Tube 330 mm 72-000-100 5mm  
430 mm 74-000-100 5mm



5 mm	Working Length	Handle 72-000-101	Handle 72-000-103	Handle 72-000-105	Handle 72-000-107	Handle 72-000-147
	330 mm					
	430 mm					
	<b>ALLIS, Grasping forceps, atraumatic, with tungsten carbide</b>					
	72-117-000		72-117-103		72-117-107	
	<b>KOCHER, Grasping forceps, atraumatic, De Bakey</b>					
	72-171-000		72-171-103		72-171-107	
	<b>Dissecting forceps, curved</b>					
	72-073-000		72-073-101			
	<b>Dissecting forceps 90 curved, using with 12,5 mm trocar sleeve</b>					
	72-067-000		72-067-101			
	<b>Endo-Forceps with single De Bakey, closing protection</b>					
	72-198-000		72-198-103		72-198-107	
	<b>Endo-Lung Palpation forceps</b>					
	72-233-000		72-233-101		72-233-105	
	<b>Needle holder with tungsten carbide inserts 8 mm</b>					
	72-201-000		72-201-147			
	<b>Needle holder with tungsten carbide inserts 10 mm</b>					
	72-203-000		72-203-147			
	<b>Suture fixation forceps, U-shaped jaws</b>					
	72-248-000		72-248-147			

Outer Tube 330 mm 72-000-100 5mm













10 mm	Working Length	Handle 72-000-202	Handle 72-000-204	Handle 72-000-206	Handle 72-000-208	
	330 mm					
	<b>Operating scissors, large</b>					
	72-084-000		72-084-202		72-084-206	
	<b>Spoon forceps, large</b>					
	72-180-000		72-180-204		72-180-208	
	<b>Claw forceps 2x3 teeth</b>					
	72-179-000		72-179-204		72-179-208	
	<b>Grasping forceps, heavy pattern</b>					
	72-225-000		72-225-204		72-225-208	
	<b>MARYLAND, Dissecting forceps, curved</b>					
	72-074-000		72-074-202			
	<b>ALLIS, Grasping forceps</b>					
	72-101-000		72-101-204		72-101-208	
	<b>ALLIS, Grasping forceps, atraumatic, De Bakey</b>					
	72-108-000		72-108-204		72-108-208	
	<b>ALLIS, Grasping forceps, atraumatic, with tungsten carbide</b>					
	72-214-000		72-214-204		72-214-208	
	<b>BABCOCK, Grasping forceps</b>					
	72-120-000		72-120-204		72-120-208	

Outer Tube 330 mm 72-000-200 10mm















<p><b>10 mm</b></p> 	<p>Working Length</p>	<p>Handle 72-000-202</p> 	<p>Handle 72-000-204</p> 	<p>Handle 72-000-206</p> 	<p>Handle 72-000-208</p> 		
	<p><b>330 mm</b></p>						
		<p><b>BABCOCK, Grasping forceps, atraumatic, De Bakey</b></p>					
		<p>72-123-000</p>		<p>72-123-204</p>		<p>72-123-208</p>	
	<p><b>BABCOCK, Grasping forceps, atraumatic, with tungsten carbide</b></p>						
	<p>72-220-000</p>		<p>72-220-204</p>		<p>72-220-208</p>		
	<p><b>DUVAL, Grasping forceps</b></p>						
	<p>72-176-000</p>		<p>72-176-204</p>		<p>72-176-208</p>		
	<p><b>COLLIN, Grasping forceps, atraumatic</b></p>						
	<p>72-181-000</p>		<p>72-181-204</p>		<p>72-181-208</p>		
	<p><b>COLLIN, Grasping forceps, atraumatic, with tungsten carbide inserts</b></p>						
	<p>72-074-000</p>		<p>72-074-202</p>				
	<p><b>Dissecting-Grasping forceps, atraumatic, De Bakey</b></p>						
	<p>72-080-000</p>		<p>72-080-202</p>				

Outer Tube **330 mm 72-000-200 10mm**



<b>10 mm</b>	Jaw Length	Working Length	Handle 72-000-202	Handle 72-000-204	Handle 72-000-206	Handle 72-000-208
	Diameter	<b>330 mm</b>				
	<b>KOCHER, Grasping forceps, atraumatic</b>					
	30MM / 10MM	72-126-000		72-126-204		72-126-208
	40MM / 10MM	72-129-000		72-129-204		72-129-208
	50MM / 10MM	72-132-000		72-132-204		72-132-208
	60MM / 10MM	72-135-000		72-135-204		72-135-208
	<b>KOCHER, Grasping forceps, atraumatic, single De Bakey</b>					
	30MM / 10MM	72-141-000		72-141-204		72-141-208
	40MM / 10MM	72-144-000		72-144-204		72-144-208
	50MM / 10MM	72-147-000		72-147-204		72-147-208
	60MM / 10MM	72-150-000		72-150-204		72-150-208
	<b>KOCHER, Grasping forceps, atraumatic, double De Bakey</b>					
	30MM / 10MM	72-156-000		72-156-204		72-156-208
	40MM / 10MM	72-159-000		72-159-204		72-159-208
	50MM / 10MM	72-162-000		72-162-204		72-162-208
	60MM / 10MM	72-165-000		72-165-204		72-165-208
	<b>Endo-Forceps with single De Bakey, closing protection</b>					
	40MM / 10MM	72-195-000		72-195-204		72-195-208
	50MM / 10MM	72-196-000		72-196-204		72-196-208
	60MM / 10MM	72-197-000		72-197-204		72-197-208
	<b>Endo-Forceps with double De Bakey, closing protection</b>					
	40MM / 10MM	72-191-000		72-191-204		72-191-208
	50MM / 10MM	72-192-000		72-192-204		72-192-208
	60MM / 10MM	72-193-000		72-193-204		72-193-208
	<b>Endo-Lung Palpation forceps</b>					
	40MM / 10MM	72-230-000		72-230-202		72-230-206
	50MM / 10MM	72-231-000		72-231-202		72-231-206
	60MM / 10MM	72-232-000		72-232-202		72-232-206

Outer Tube **330 mm 72-000-200 10mm**



The good results of open abdominal surgery can hardly be improved upon using the conventional techniques. Through the application of modern video -endoscopic technology and appropriate instruments, however, the trauma of operative access can be substantially reduced. Small punctures replace abdominal sections. The advantages of minimal invasive surgery are the results.

With a number of new developed instruments *Germed USA Inc.* would like to make an up-to-date contribution to laparoscopic operating techniques.

For neat preparation of the operation situs during laparoscopic operations, *GermedUSA Inc.* now offers you the ideal balanced set of instruments developed in accordance with hundreds of tried and tested examples from classic abdominal surgery.

The new *Germed USA Inc.* Endo Hook System  
The Endo Hook System newly developed by *GermedUSA Inc.* is a rod-shaped instrument having a diameter of 5mm and 10mm and on whose front end an Endo hook is fixed. At the top end of the instrument a handle with an operating mechanism is mounted, allowing for infinitely variable adjustment of the respective hook, from 0 to 90 degrees. Thus, with the help of an appropriate *Germed USA Inc.* Endo hook, it is possible to achieve the same beneficial effects as with hooks used in classic abdominal surgery.

### ASSEMBLED INSTRUMENT



### DISASSEMBLED INSTRUMENT











### Insert, with instrument tip



### Handle







### Outer tube with screw cap

<b>10 mm</b>	Jaw Length	Working Length	Handle 72-000-159	Handle 72-000-260		
	Diameter	<b>330 mm</b>				
	<b>Endo-Retractor Kocher-Langenbeck</b>					
	30MM / 10MM	77-001-000		77-001-159		
	40MM / 10MM	77-002-000		77-002-159		
	50MM / 10MM	77-003-000		77-003-159		
	30MM / 10MM	77-011-000		77-011-260		
	40MM / 10MM	77-012-000		77-012-260		
	50MM / 10MM	77-013-000		77-013-260		
	<b>Endo-Retractor Cushing</b>					
	30MM / 10MM	77-015-000		77-015-260		
	40MM / 10MM	77-016-000		77-016-260		
	50MM / 10MM	77-017-000		77-017-260		
	<b>Endo-Retractor fan-shaped</b>					
	50MM / 5MM	77-021-000		77-021-159		
	60MM / 5MM	77-022-000		77-022-159		
	50MM / 10MM	77-023-000		77-023-260		
	60MM / 10MM	77-024-000		77-024-260		
	<b>Endo-Esophageal-Retractor/Dissector</b>					
	35MM / 5MM	77-030-000		77-030-159		
	35MM / 10MM	77-031-000		77-031-260		
	<b>Endo-Esophageal-Retractor/Dissector</b>					
	35MM / 10MM	77-032-000		77-032-260		
	<b>Endo-Laparolifter (in conjunction with CO2 insufflation)</b>					
	40MM / 10MM	77-052-000		77-052-260		

Outer Tube    330 mm 72-000-200 10mm  
                   330 mm 72-000-100 5mm



<p><b>10 mm</b></p>	<p>Jaw Length</p> <p>Diameter</p>	<p>Working Length</p> <p><b>330 mm</b></p>	<p>Handle</p> <p>72-000-260</p> 									
	<p><b>Endo-Eccentric "Y" Retractor</b></p> <table border="1"> <tr> <td data-bbox="349 485 540 561"> <p>40-60MM / 10MM</p> </td> <td data-bbox="540 485 748 561"> <p>72-600-000 R</p> </td> <td data-bbox="748 485 943 561"></td> <td data-bbox="943 485 1141 561"> <p>72-600-260 R</p> </td> <td data-bbox="1141 485 1339 561"></td> <td data-bbox="1339 485 1529 561"></td> </tr> </table>						<p>40-60MM / 10MM</p>	<p>72-600-000 R</p>		<p>72-600-260 R</p>		
<p>40-60MM / 10MM</p>	<p>72-600-000 R</p>		<p>72-600-260 R</p>									
	<p><b>Endo-Eccentric "Y" Retractor</b></p> <table border="1"> <tr> <td data-bbox="349 790 540 866"> <p>60-40MM / 10MM</p> </td> <td data-bbox="540 790 748 866"> <p>72-600-000 L</p> </td> <td data-bbox="748 790 943 866"></td> <td data-bbox="943 790 1141 866"> <p>72-600-260 L</p> </td> <td data-bbox="1141 790 1339 866"></td> <td data-bbox="1339 790 1529 866"></td> </tr> </table>						<p>60-40MM / 10MM</p>	<p>72-600-000 L</p>		<p>72-600-260 L</p>		
<p>60-40MM / 10MM</p>	<p>72-600-000 L</p>		<p>72-600-260 L</p>									
	<p><b>Endo-Eccentric "Y" Retractor</b></p> <table border="1"> <tr> <td data-bbox="349 1056 540 1132"> <p>60-60MM / 10MM</p> </td> <td data-bbox="540 1056 748 1132"> <p>72-600-000 S</p> </td> <td data-bbox="748 1056 943 1132"></td> <td data-bbox="943 1056 1141 1132"> <p>72-600-260 S</p> </td> <td data-bbox="1141 1056 1339 1132"></td> <td data-bbox="1339 1056 1529 1132"></td> </tr> </table>						<p>60-60MM / 10MM</p>	<p>72-600-000 S</p>		<p>72-600-260 S</p>		
<p>60-60MM / 10MM</p>	<p>72-600-000 S</p>		<p>72-600-260 S</p>									

Outer Tube

**330 mm 72-000-200 10mm**



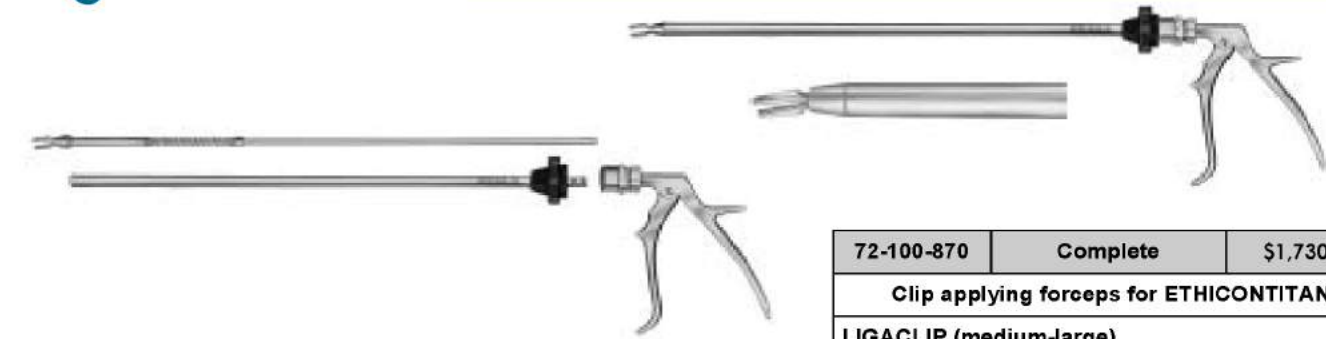

72-100-870	Complete	\$1,730.00
<b>Clip applying forceps for ETHICONTITAN</b>		
<b>LIGACLIP (medium-large)</b>		
consisting of:		
72-100-000	Insert, forceps	\$580.00
72-100-800	Outer tube 10 mm	Call for code
72-100-070	Handle	Cal for code
Further forceps Inserts, on request		



78-00500	\$70.00
----------	---------

**Applicator for endo-ligature, 5mm**



78-00501	\$170.00
----------	----------

**Knot-sliding instrument, 5mm**



78-00502	\$180.00
----------	----------

**Knot guide for extracorporeal knotting, 5mm  
(only useable with applicator 78-00500)**



78-00503	\$130.00
----------	----------

**Knot guide for extracorporeal knotting, 5mm  
(only useable with applicator 78-00500)**

Endoscope and Instrument Holder	
72-700-000	Call for code
components:	
Germed Articulating post # -3800-40	
(400 mm) fixed with the handle	
Endoscope and Instrument Holder 10 mm	
Thread base on rails 25x10 and 35x8 mm	
Support 300 mm, adjustment of height	





Cleaning Brush, 500 mm length		
79-00011	for Outer tube 5 mm insulated / metal and Outer tube 10 mm insulated	\$16.00
79-00012	for Outer tube 10 mm metal	\$16.00



Instrument Oil P-102		
79-00010	50 ml	\$60.00

**Handles for rotating and detachable  
5 mm and 10 mm Instruments:**

**Handles for detachable  
5 mm and 10 mm Instruments:**



72-000-101	5 mm	\$220.00
72-000-202	10 mm	Call for code
with HF-connector		
without ratchet		



72-000-121	5 mm	Call for code
72-000-222	10 mm	Call for code
with HF-connector		
without ratchet		



72-000-103	5 mm	\$260.00
72-000-204	10 mm	Call for code
with HF-connector		
with ratchet		

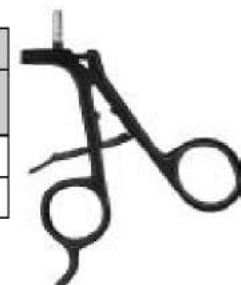

72-000-123	5 mm	Call for code
72-000-224	10 mm	Call for code
with HF-connector		
with ratchet		



72-000-105	5 mm	\$260.00
72-000-206	10 mm	Call for code
without ratchet		



72-000-125	5 mm	Call for code
72-000-226	10 mm	Call for code
without ratchet		



72-000-107	5 mm	\$300.00
72-000-208	10 mm	Call for code
with ratchet		



72-000-127	5 mm	Call for code
72-000-228	10 mm	Call for code
with ratchet		

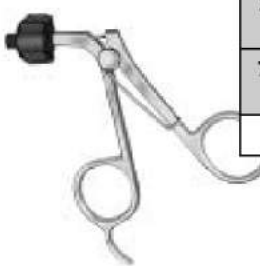

72-000-109	5 mm	Call for code
72-000-210	10 mm	Call for code
metal spring action		



72-000-129	5 mm	Call for code
72-000-230	10 mm	Call for code
metal spring action		



## Handles for rotating and detachable 5 mm and 10 mm Instruments:



72-000-141	5 mm	
72-000-242	10 mm	
without ratchet		

72-000-143	5 mm	
72-000-244	10 mm	
with ratchet		

## Handles for detachable 5 mm and 10 mm Instruments:



72-000-145	5 mm	
72-000-246	10 mm	
without ratchet		

72-000-147	5 mm	
72-000-248	10 mm	
with ratchet		



72-000-159	5 mm	
72-000-260	10 mm	

## Spare Parts



72-000-100	5 mm	Outer tube insulated	
72-000-300	5 mm	Outer tube metal	

Outer tube with screw cap for 5 mm Instruments



72-000-200	10 mm	Outer tube insulated	
72-000-400	10 mm	Outer tube metal	

Outer tube with screw cap for 10 mm Instruments



72-000-500	
------------	--

Screw cap for 5 mm Instruments



72-000-600	
------------	--

Screw cap for 10 mm Instruments

**ASSEMBLED INSTRUMENT**



**DISASSEMBLED INSTRUMENT**

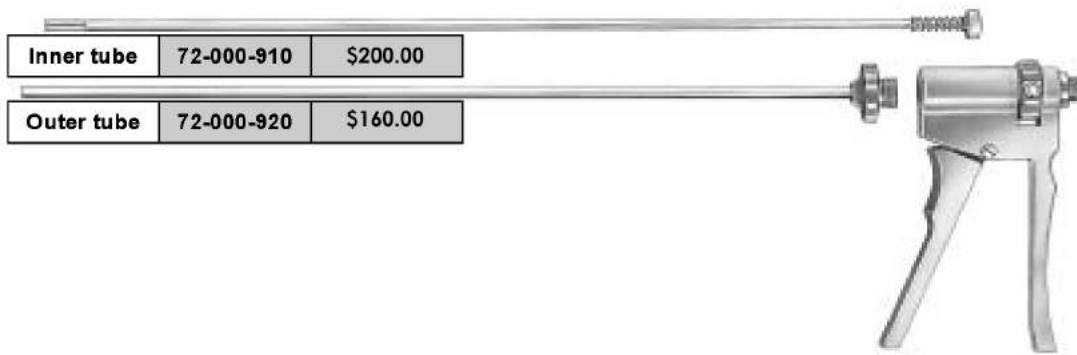

Inner tube	72-000-910	\$200.00
------------	------------	----------

Outer tube	72-000-920	\$160.00
------------	------------	----------

Handle	
72-000-980	\$690.00



72-210-980	Complete	\$1,300.00
<b>Bipolar Forceps 1 mm, complete,</b>		
consisting of:		
72-210-000	Insert forceps	\$300.00
72-000-920	Outer tube 5 mm	\$160.00
72-000-910	Inner tube	\$200.00
72-000-980	Handle	\$690.00



72-211-980	Complete	\$1,300.00
<b>Bipolar Forceps 3 mm, complete,</b>		
consisting of:		
72-211-000	Insert forceps	\$300.00
72-000-920	Outer tube 5 mm	\$160.00
72-000-910	Inner tube	\$200.00
72-000-980	Handle	\$690.00

**Detachable Bipolar Coagulation Forceps**

**5 mm x 340 mm**

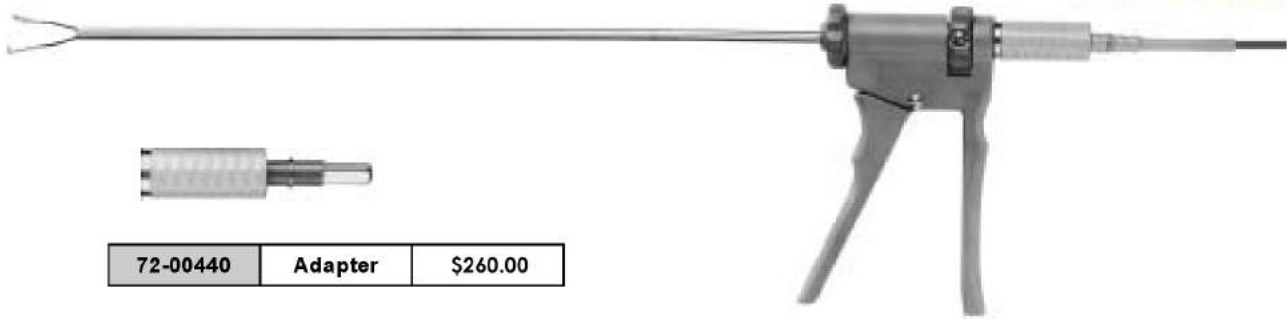

72-00440	Adapter	\$260.00
----------	---------	----------



72-212-980	Complete	\$1,300.00
<b>Bipolar Forceps complete,</b>		
consisting of:		
72-212-000	Insert forceps	\$300.00
72-000-920	Outer tube 5 mm	\$160.00
72-000-910	Inner tube	\$200.00
72-000-980	Handle	\$690.00



72-213-981	Complete	\$1,760.00
<b>Bipolar Scissors complete,</b>		
consisting of:		
72-213-000	Insert forceps	\$660.00
72-000-920	Outer tube 5 mm	\$160.00
72-000-910	Inner tube	\$260.00
72-000-981	Handle	\$760.00



72-00400	\$390.00
<b>Valleylab-Plug</b>	



72-00420	\$260.00
<b>Erbe-Plug</b>	



72-00410	\$300.00
<b>Codman-Plug</b>	



72-00430	\$420.00
<b>Martin/Berchtold-Plug</b>	



**Bowel Forceps**

78-00200	\$240.00
----------	----------



**Atraumatic Grasping forceps**

78-00201	\$240.00
----------	----------



**Fimbrial Holding Forceps, t-pattern**

78-00202	\$240.00
----------	----------



**Fimbrial Holding Forceps, square pattern**

78-00203	\$240.00
----------	----------



**Fimbrial Holding Forceps, ring pattern**

78-00204	\$260.00
----------	----------



**Swab Grasper**

78-00205	\$300.00
----------	----------