

# GYNECOLOGY INSTRUMENTS



*GerMed*USA™

**ADDRESS:** 2417 Jericho Turnpike, #333, Garden  
City Park, NY 11040 (USA).  
**PHONE:** 800-330-1322 | +1(516) 997-2180  
**FAX:** 800-260-7177 | +1(516) 358 2182  
**EMAIL:** [sales@GerMedUSA.com](mailto:sales@GerMedUSA.com)

About the Company	2
Trocar Sleeves, Trocars	3-5
Reducer Sleeves, Dilation Set, LAP-Accessories	6
Autoclavable Laparoscopes	7
Fiber Light Cables	8
Hook-tip Electrodes	9-12
Suction and Irrigation Tubes	13-14
Accessories for Laparoscopy / Cholecystectomy	15
Rotating and Detachable Instruments	16-32
Endo-Hook-System	33-35
Clip-Applier and Knot slider	36
Care and Cleaning	37
Handles	38-39
Detachable Forceps (Bipolar)	40-41
Graspers with Spring-Handle	42
Rotating and Detachable Instruments	43-47

Special models available upon request

## ABOUT US

**GerMedUSA Inc.** is the leading manufacturer of high-quality surgical instruments worldwide. At most economical prices, we offer premium quality surgical instruments, immediately available for delivery anywhere in the world. Our broad range of surgical instruments undergoes a series of quality control testing to get excellent products. We offer a wide selection of Surgical Instruments, including; Dental Instruments, Orthopedic Surgical Instruments, Operating Room Surgical Instruments, Podiatry Surgical Instruments, Rainbow Surgical Instruments, Left Hand Instruments, Thoracoscopy, Gynecological Instruments, Dermal Instruments, Ear Instruments, Eye Instruments, Hemostatic Forceps, Cardiovascular Thoracic Instruments, Floor Grade Economy Instruments, and Tungsten Carbide Insert Needle Holders and Scissors.

**GerMedUSA Inc.** journey that began three decades ago has successfully become a symbol of Excellence, Innovation, and Reliability for veterinarians worldwide. Strictly following the **FDA** guidelines and being **ISO 13485 certified**, all our procedures are documented, and every process is being monitored at every level. We have acquired an unmatched and unique understanding of manufacturing. Our state-of-the-art manufacturing facilities and years of experience have helped us keep prices low and provide quality products. We believe more in building a strong relationship than just selling the instruments. Therefore, we enjoy providing superior customer services from the first query to the last and offer free sharpening on all our Scissors for the life of the instrument & all Dental Elevators/Luxating Elevators.

Yet, **GerMedUSA Inc.** believes that there is no end when it comes to success and perfection. Therefore, we continuously work with top-notch professionals to understand the changing market needs and future trends to develop the instruments that make them fall in love with their job. Our team of Expert Consultants is available for you whenever you need them. Order a free CD-Rom "Our electronic catalog" to save your time and deliver your order without any hassle.

Want to talk to us? Start a live chat or reach out to us via social media platforms. Or if you are looking for an instrument that we do not have, please get in touch, we will manufacture it for you.

We would love your honest feedback about what we are doing great and what improvements we need. Thanks in advance for your time and input.

## Guarantee

All our surgical instruments are guaranteed to be free from any defects in material and workmanship. Any material or instrument found to be defective will either be replaced or repaired based on the evaluation. This service is free of any cost. Our responsibility under guarantee shall be limited to only replacement and repaired policy of defective merchandise.

Trocar Sleeves with Trumpet Valve and Stopcock

77-00505	5 mm	\$1,630.00	77-00509	10.5 mm	\$470.00
77-00506	5.5 mm	\$410.00	77-00511	11 mm	\$470.00
77-00510	10 mm	\$410.00	77-00512	12.5 mm	\$470.00

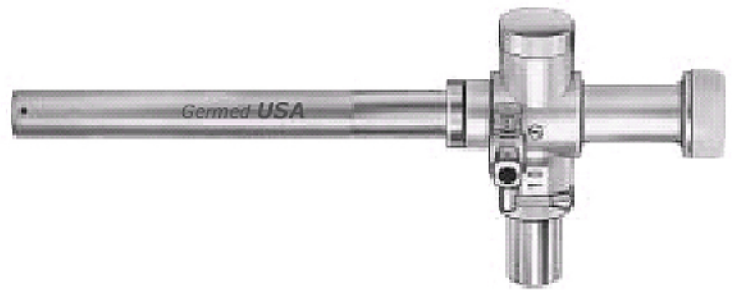

Reducer PPSU

77-00568	10 mm — 5.5 mm	\$470.00
77-00569	11 mm — 5 mm	\$60.00
77-00570	12.5 mm — 10 mm	\$60.00
77-00571	12.5 mm — 5.5 mm	\$60.00



Trocars with Three-edged Tip, suitable for metal (and plastic) Trocar Sleeves

77-01505	5 mm	\$100.00	77-01509	10.5 mm	\$100.00
77-01506	5.5 mm	\$100.00	77-01511	11 mm	\$100.00
77-01510	10 mm	\$100.00	77-01513	12.5 mm	\$100.00



Trocars with Conical Tip

77-02505	5 mm	\$100.00	77-02509	10.5 mm	\$100.00
77-02506	5.5 mm	\$100.00	77-02511	11 mm	\$100.00
77-02510	10 mm	\$100.00	77-02513	12.5 mm	\$100.00



Reuseable Safety Trocar (3-edged grinding)

77-01025	5 mm	\$100.00	77-01031	11 mm	\$100.00
77-01026	5.5 mm	\$100.00	77-01032	12.5 mm	\$100.00
77-01030	10 mm	\$100.00			





## Trocar Sleeves with Trumpet Valve

77-00515	15 mm	\$700.00
77-00520	20 mm	\$600.00

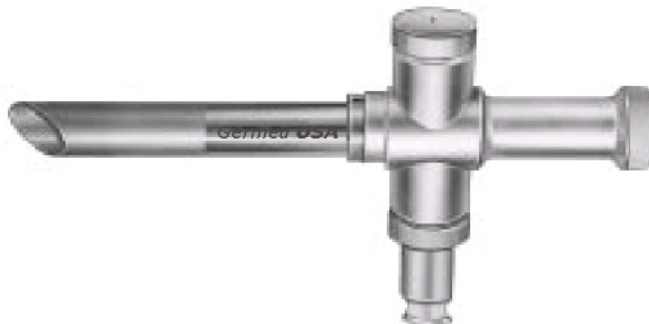

## Trocars with Three-edged Tip

77-01515	15 mm	\$110.00
77-01520	20 mm	\$110.00



## Trocars with Conical Tip

77-02515	15 mm	\$100.00
77-02520	20 mm	\$100.00



## Spare Parts for Trocar Sleeve

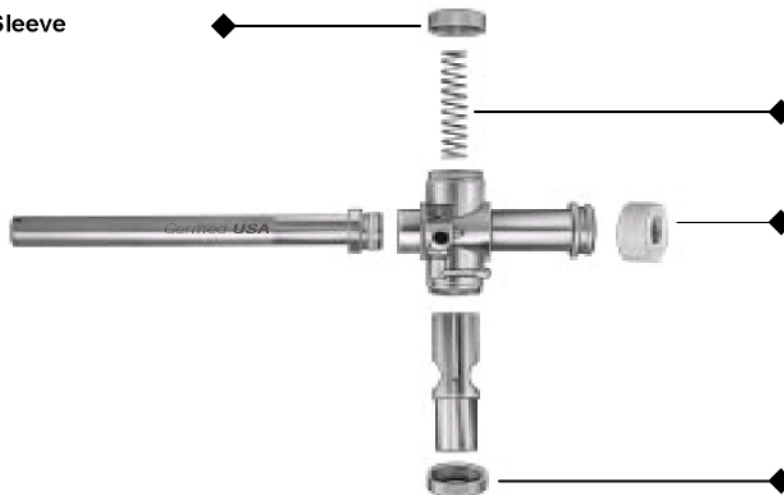

Trocar sizes	Valve cap, closed	Spring	Sealing cap, 10 pieces	Valve cap, open
5 mm	77-00600	77-00610	77-00620	77-00630
5.5 mm	77-00601	77-00611	77-00621	77-00631
10 mm	77-00602	77-00612	77-00622	77-00632
10.5 mm	77-00603	77-00613	77-00623	77-00633
11 mm	77-00604	77-00614	77-00624	77-00634
12.5 mm	77-00605	77-00615	77-00625	77-00635
15 mm	77-00606	77-00616	77-00626	77-00636
20 mm	77-00607	77-00617	77-00627	77-00637

## Trocar Sleeves with Stopcock and Folding Valve

77-00535	5 mm	\$470.00
77-00536	5.5 mm	\$470.00
77-00540	10 mm	\$490.00
77-00541	11 mm	\$500.00
77-00542	12.5 mm	\$500.00



## Automatic Trocar Sleeve with Manual Trap Door

77-00735	5 mm	\$540.00
77-00736	5.5 mm	\$540.00
77-00740	10 mm	\$570.00
77-00741	11 mm	\$570.00
77-00742	12.5 mm	\$600.00



## Spare Parts for Trocar Sleeves

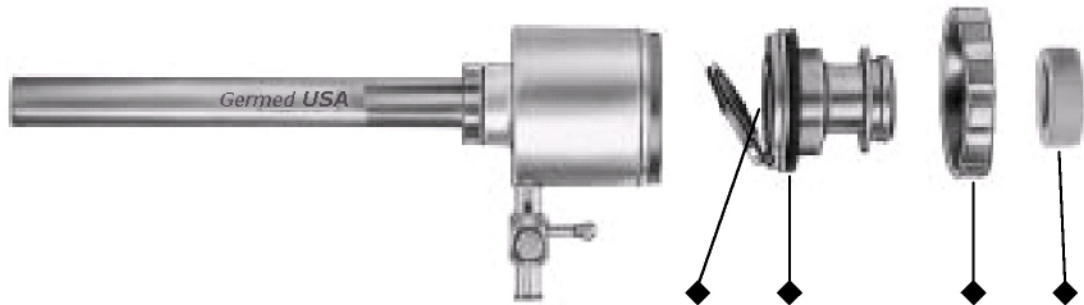

Trocar sizes	Sealing ring, 10 pieces		Sealing ring, 10 pieces		Screw cap		Sealing cap, 10 pieces	
5 mm	77-00700	\$120.00	77-00710	\$120.00	77-00720	\$40.00	77-00730	\$60.00
5.5 mm	77-00701	\$120.00	77-00711	\$120.00	77-00721	\$40.00	77-00731	\$60.00
10 mm	77-00702	\$120.00	77-00712	\$120.00	77-00722	\$40.00	77-00732	\$60.00
10.5 mm	77-00703	\$80.00	77-00713	\$80.00	77-00723	\$50.00	77-00733	\$60.00
11 mm	77-00704	\$80.00	77-00714	\$80.00	77-00724	\$50.00	77-00734	\$60.00
12.5 mm	77-00705	\$80.00	77-00715	\$80.00	77-00725	\$60.00	77-00735	\$70.00



**Reducer Sleeve**

77-00113	15 mm —10 mm	\$90.00
77-00114	15 mm —11 mm	\$90.00
77-00116	20 mm — 5 mm	\$90.00
77-00118	20 mm —10 mm	\$100.00
77-00120	20 mm —11 mm	\$100.00



**Trocar-Stop**

77-00090	5 mm	\$100.00	77-00093	10.5 mm	\$100.00
77-00091	5.5 mm	\$100.00	77-00094	11 mm	\$100.00
77-00092	10 mm	\$100.00	77-00095	12.5 mm	\$100.00



**Dilation Sets, consisting of dilation rod and dilation sleeve**

77-00132	5 mm —10 mm	\$120.00	77-00146	10 mm —20 mm	\$210.00
77-00140	5 mm —15 mm	\$210.00	77-00148	11 mm —15 mm	\$210.00
77-00142	5 mm — 20 mm	\$210.00	77-00150	11 mm —20 mm	\$220.00
77-00144	10 mm —15 mm	\$210.00			



**Insufflation Needle acc. To Veress**

77-00160	2.00 x 100 mm	\$220.00
77-00162	2.00 x 120 mm	\$100.00
77-00164	2.00 x 140 mm	\$100.00
77-00165	2.00 x 150 mm	\$100.00
77-00170	2.00 x 200 mm	\$110.00



**Palpation probe graduated**

77-03510	330 mm	5 mm	\$110.00
77-03511	450 mm	5mm	\$80.00

All telescopes are equipped with a 3-way variable cable connector to connect the following systems:

ACM, BRITISH, WOLF, HSW, STORTZ, OLYMPUS



**Optics for Laparoscopy**  
Autoclavable at 2, 3 bar (134°C)

71-00010	5 mm	direct vision	0°	\$90.00
71-00020	5 mm	foroblique	30°	\$5,030.00
71-00030	10 mm	direct vision	0°	\$5,180.00
71-00040	10 mm	foroblique	30°	\$4,750.00
71-00050	10mm	direct vision	45°	\$4,890.00



**Sterilizable Optic Heater** protects the optics outside of the OP-field of loss of heat

71-00100	for 5 mm Optics	\$5,800.00
71-00110	for 10 mm Optics	\$90.00





Fiber Light Cables, Autoclavable at 2 bar (134°C)

Endoskop-Adapter		180 length		230 length		300 length	
Rema / Storz	4.8	71-00200	\$450.00	71-00210	\$440.00	71-00220	\$700.00
	6.0	71-00201	\$950.00	71-00211	\$1,150.00	71-00221	\$1,310.00
Winter / Ibe	4.8	71-00202	\$560.00	71-00212	\$660.00	71-00222	\$790.00
	6.0	71-00203	\$950.00	71-00213	\$1,170.00	71-00223	\$1,320.00
Wolf / HSW	4.8	71-00204	\$570.00	71-00214	\$690.00	71-00224	\$800.00
	6.0	71-00205	\$960.00	71-00215	\$1,150.00	71-00225	\$1,330.00
ACM / British	4.8	71-00206	\$550.00	71-00216	\$690.00	71-00226	\$800.00
	6.0	71-00207	\$960.00	71-00217	\$1,150.00	71-00227	\$1,330.00

angle connection for projector side

71-00300

Type A



Type B



HF Connection Cables

72-00000	Type A	3.50 m Length	\$90.00
72-00500	Type B	3.50 m Length	\$100.00

Hook-tip electrodes insulated up to the front,  
To the maximum extent

Type A



Type B



Blunt	Type A		Type B	
Length 330 mm	72-00001	\$100.00	72-00501	\$160.00
Length 450 mm	72-00101	\$250.00	72-00601	\$250.00



Diamond Shaped Cutting Surface	Type A		Type B	
Length 330 mm	72-00002	\$160.00	72-00502	\$250.00
Length 450 mm	72-00102	\$250.00	72-00602	\$160.00



Blunt	Type A		Type B	
Length 330 mm	72-00003	\$160.00	72-00503	\$160.00
Length 450 mm	72-00103	\$250.00	72-00603	\$250.00



Diamond Shaped Cutting Surface	Type A		Type B	
Length 330 mm	72-00004	\$160.00	72-00504	\$160.00
Length 450 mm	72-00104	\$250.00	72-00604	\$250.00



Diamond Shaped Cutting Surface	Type A		Type B	
Length 330 mm	72-00005	\$160.00	72-00505	\$160.00
Length 450 mm	72-00105	\$250.00	72-00605	\$250.00

Hook-tip electrodes insulated up to the front,  
To the maximum extent, as well as on the back up to the tip

Type A



Type B



Blunt Curved	Type A		Type B	
Length 330 mm	72-00011	\$160.00	72-00511	\$290.00
Length 450 mm	72-00111	\$180.00	72-00611	\$280.00



Diamond Shaped Cutting Surface	Type A		Type B	
Length 330 mm	72-00012	\$290.00	72-00512	\$310.00
Length 450 mm	72-00112	\$300.00	72-00612	\$300.00



Blunt	Type A		Type B	
Length 330 mm	72-00013	\$310.00	72-00513	\$300.00
Length 450 mm	72-00113	\$290.00	72-00613	\$290.00



Diamond Shaped Cutting Surface	Type A		Type B	
Length 330 mm	72-00014	\$300.00	72-00514	\$310.00
Length 450 mm	72-00114	\$300.00	72-00614	\$300.00



Diamond Shaped Cutting Surface	Type A		Type B	
Length 330 mm	72-00015	\$310.00	72-00515	\$310.00
Length 450 mm	72-00115	\$300.00	72-00615	\$290.00

Type A



Type B



Button Tip Electrode	Type A		Type B	
Length 300 mm	72-00020	\$330.00	72-00520	\$240.00
Length 450 mm	72-00120	\$170.00	72-00620	\$240.00



Cone Tip Electrode	Type A		Type B	
Length 300 mm	72-00021	\$170.00	72-00521	\$240.00
Length 450 mm	72-00121	\$260.00	72-00621	\$250.00



Knife Tip Electrode	Type A		Type B	
Length 300 mm	72-00022	\$180.00	72-00522	\$260.00
Length 450 mm	72-00122	\$250.00	72-00622	\$290.00



Loop Tip Electrode	Type A		Type B	
Length 300 mm	72-00023	\$170.00	72-00523	\$240.00
Length 450 mm	72-00123	\$260.00	72-00623	\$250.00





Coagulation and suction-cannula, insulated, with trumpet valve

73-00001	\$280.00
----------	----------



Dissecting Spatula, insulated, with trumpet valve and suction

73-00002	\$280.00
----------	----------



Dissecting Hook, insulated, with trumpet valve and suction

73-00003	\$280.00
----------	----------



Dissecting Hook, right-angled, insulated, with trumpet valve and suction

73-00004	\$300.00
----------	----------



Coagulation and suction-cannula, insulated

73-00011	\$160.00
----------	----------



Dissecting Spatula, insulated, with suction

73-00012	\$160.00
----------	----------



Dissecting Hook, insulated, with suction

73-00013	\$160.00
----------	----------



Dissecting Hook, right-angled, insulated, with suction

73-00014	\$160.00
----------	----------

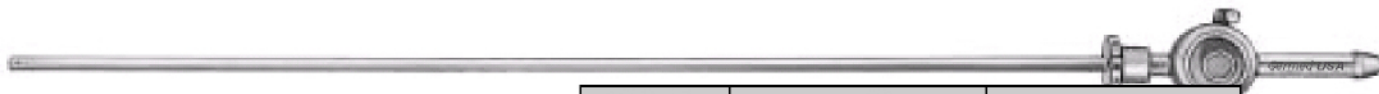

73-00600	Complete	\$880.00
Suction-Irrigation tube set 5 mm consisting of:		
7 Suction-Irrigation tubes Fig. 1 to 7		
1 Sliding Valve		
73-00601	Sliding valve only	\$360.00

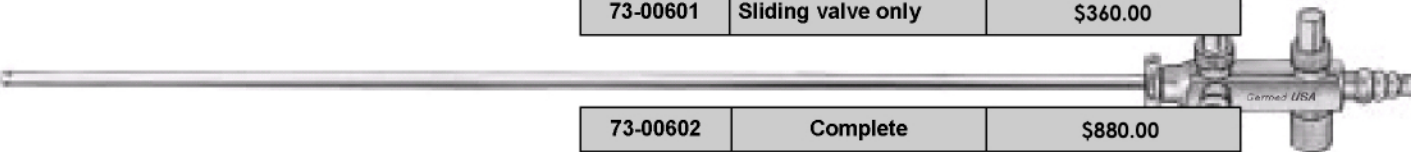

73-00602	Complete	\$880.00
Suction-Irrigation tube set 5 mm consisting of:		
7 Suction-Irrigation tubes Fig. 1 to 7		
1 Trumpet Valve		
73-00603	Trumpet valve only	\$380.00



Suction-Irrigation tube		
73-00610	Fig. 1	\$70.00



Suction-Irrigation tube		
73-00611	Fig. 2	\$70.00



Suction-Irrigation tube		
73-00612	Fig. 3	\$70.00
73-00613	Fig. 4	\$80.00

see above, but 500mm



Suction-Irrigation tube		
73-00614	Fig. 5	\$70.00



Suction-Irrigation tube		
73-00615	Fig. 6	\$90.00



Suction-Irrigation tube		
73-00616	Fig. 7	\$90.00



73-00620	Complete	\$690.00
Suction-Irrigation tube set 5 mm		
73-00621	Suction-Irrigation tube 5 mm	\$70.00
73-00622	Suction-Irrigation tube 10 mm	\$70.00
73-00623	Trumpet valve	\$620.00



73-00008	\$320.00
----------	----------

Suction and Irrigation tube, with central tube laser fiber



73-00005	\$360.00
----------	----------

Suction and Irrigation tube, with central tube laser fiber



73-00006	\$140.00
----------	----------

Suction tube with stop cock, Luer Lock



73-00007	\$290.00
----------	----------

Suction and Irrigation tube with two trumpet valves



73-00015	6 mm	\$20.00
73-00016	8 mm	\$20.00
connector, Luer Lock		
(female)		



73-00017	6 mm	\$20.00
73-00018	8 mm	\$20.00
connector, Luer Lock		
(male)		



73-00039	\$1,050.00
----------	------------

Cholangiographie Fixation forceps



73-00041	\$80.00
----------	---------

Injection and puncture needle, LuerLock



73-00042	\$100.00
----------	----------

Two-way stopcock for contrast medium



73-00043	\$80.00
----------	---------

Guide tube for Cholangi catheter



73-00044	\$70.00
----------	---------

Guide hook for Cholangi catheter



**GermedUSA Inc.****INSTRUMENT LINE** - *easy change*















The following benefits offers the newest *GermedUSA* Laparoscopy instrument line "easy change".

- Ergonomic light design, excellent cleaning quality e.g. fast, effective and simple. Every instrument features additionally extra fast cleaning possibility via "Luer Lock".
- Very easy and simple handling as handle can be removed by pressing with one finger, this corresponds to a quick lock as no screws are used any longer.
- For handles with ratchet we developed a new comfortable ratchet design with easy handling. The users finger posture is the same like holding a handle without ratchet.

The handicap through the traditional ratchet on the handle is cancelled.















"Easy change line" is in 5mm and in 10mm available. **NEW!!** For 5mm inserts as well as for the 10mm you use the same handle. All instruments are 360 rotatable and auto-clavable. Can be taken apart fast and easily into 3 parts: handle, outer tube and working insert.



5 mm	Working Length	Handle 75-000-101	Handle 75-000-103	Handle 75-000-105	Handle 75-000-107	Handle 75-000-147
	330 mm					
	430 mm					
	<b>Hook scissors, straight</b>					
	75-051-000	\$370.00	75-051-101	\$770.00		
	76-051-000	\$370.00	76-051-101	\$770.00		
	<b>Peritoneal scissors, straight</b>					
	75-082-000	\$370.00	75-082-101	\$770.00		
	76-082-000	\$370.00	76-082-101	\$770.00		
	<b>Micro dissecting scissors, straight</b>					
	75-048-000	\$370.00	75-048-101	\$770.00	75-048-105	\$770.00
	<b>Micro dissecting scissors, curved left</b>					
	75-049-000	\$370.00	75-049-101	\$770.00	75-049-105	\$770.00
	<b>METZENBAUM, Dissecting scissors, short, curved</b>					
	75-047-000	\$370.00	75-047-101	\$770.00		
	<b>METZENBAUM, Dissecting scissors, straight</b>					
	75-054-000	\$370.00	75-054-101	\$770.00		
	76-054-000	\$370.00	76-054-101	\$770.00		
	<b>METZENBAUM, Dissecting scissors, curved</b>					
	75-056-000	\$370.00	75-056-101	\$770.00		
	76-056-000	\$370.00	76-056-101	\$770.00		
	<b>Biopsy forceps</b>					
	75-063-000	\$370.00	75-063-101	\$770.00		
	76-063-000	\$370.00	76-063-101	\$770.00		
	<b>Biopsy forceps with thorn</b>					
	75-064-000	\$370.00	75-064-101	\$770.00		
	76-064-000	\$370.00	76-064-101	\$770.00		

Outer Tube 330 mm 75-000-100 5mm  
430 mm 76-000-100 5mm







<b>5 mm</b>	Working Length	Handle 75-000-101	Handle 75-000-103	Handle 75-000-105	Handle 75-000-107	Handle 75-000-147
	<b>330 mm</b>					
	<b>430 mm</b>					
	<b>BLAKESLY, Biopsy forceps</b>					
	75-081-000	\$370.00	75-081-101	\$770.00		
	76-081-000	\$370.00	76-081-101	\$770.00		
	<b>Biopsy punch</b>					
	75-060-000	\$370.00	75-060-101	\$770.00		
	76-060-000	\$370.00	76-060-101	\$770.00		
	<b>Biopsy punch</b>					
	75-062-000	\$370.00	75-062-101	\$770.00		
	76-062-000	\$370.00	76-062-101	\$770.00		
	<b>Grasping forceps</b>					
	75-065-000	\$370.00	75-065-101	\$770.00	75-065-103	\$770.00
	76-065-000	\$370.00	76-065-101	\$770.00	76-065-103	\$770.00
	<b>Grasping forceps Fenestrated</b>					
	75-079-000	\$370.00	75-079-103	\$770.00		
	76-079-000	\$370.00	76-079-103	\$770.00		
	<b>Grasping forceps, delicate pattern</b>					
	75-066-000	\$370.00	75-066-103	\$770.00		
	76-066-000	\$370.00	76-066-103	\$770.00		
	<b>Grasping forceps, heavy pattern</b>					
	75-078-000	\$370.00	75-078-103	\$770.00		
	76-078-000	\$370.00	75-078-103	\$770.00		
	<b>Grasping forceps</b>					
	75-068-000	\$370.00	75-068-103	\$770.00		
	76-068-000	\$370.00	76-068-103	\$770.00		
	<b>Grasping forceps, pointed</b>					
	75-069-000	\$370.00	75-069-103	\$770.00		
	76-069-000	\$370.00	76-069-103	\$770.00		

Outer Tube    **330 mm 75-000-100 5mm**  
**430 mm 76-000-100 5mm**



5 mm

Working Length	Handle 75-000-101	Handle 75-000-103	Handle 75-000-105	Handle 75-000-107	Handle 75-000-147
330 mm					
430 mm					



**Grasping forceps**

75-075-000	\$380.00	75-075-103	\$800.00		
76-075-000	\$380.00	76-075-103	\$800.00		



**Dissecting forceps, atraumatic serration**

75-070-000	\$380.00	75-070-101	\$800.00	75-070-103	\$800.00
76-070-000	\$380.00	76-070-101	\$800.00	76-070-103	\$800.00



**MARYLAND, Dissecting forceps, curved**

75-072-000	\$380.00	75-072-101	\$800.00		
76-072-000	\$380.00	76-072-101	\$800.00		



**Dissecting forceps, curved 45**

75-246-000	\$380.00	75-246-101	\$800.00	75-246-105	
76-246-000	\$380.00	76-246-101	\$800.00	76-246-105	



**Dissecting forceps, curved 90**

75-247-000	\$380.00	75-247-101	\$800.00	75-247-105	\$800.00
------------	----------	------------	----------	------------	----------



**Grasping forceps, atraumatic, De Bakey**

75-242-000	\$380.00	75-242-103	\$800.00	75-242-107	\$800.00
76-242-000	\$380.00	76-242-103	\$800.00	76-242-107	\$800.00



**Grasping forceps**

75-077-000	\$380.00	75-077-103	\$800.00		
76-077-000	\$380.00	76-077-103	\$800.00		



**Grasping forceps 2x3 teeth**

75-076-000	\$380.00	75-076-103	\$800.00		
76-076-000	\$380.00	76-076-103	\$800.00		

















**Claw forceps 2x3 teeth**

75-083-000	\$380.00	75-083-103	\$800.00	75-083-107	
------------	----------	------------	----------	------------	--

Outer Tube 330 mm 75-000-100 5mm  
430 mm 76-000-100 5mm















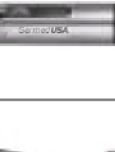

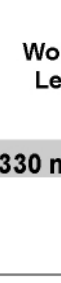
<b>5 mm</b>	Working Length	Handle 75-000-101	Handle 75-000-103	Handle 75-000-105	Handle 75-000-107	Handle 75-000-147
	<b>330 mm</b>					
	<b>430 mm</b>					
	<b>Grasping forceps HI with tungsten carbide</b>					
	75-286-000	\$420.00	75-286-103	\$850.00	75-286-107	\$850.00
	76-286-000	\$420.00	76-286-103	\$850.00	76-286-107	\$850.00
	<b>ALLIS, Grasping forceps</b>					
	75-105-000	\$420.00	75-105-103	\$850.00	75-105-107	\$850.00
	<b>ALLIS, Grasping forceps, atraumatic, De Bakey</b>					
	75-111-000	\$420.00	75-111-103	\$850.00	75-111-107	\$850.00
	<b>Endo-Forceps with single De Bakey, closing protection</b>					
	75-198-000	\$420.00	75-198-103	\$850.00	75-198-107	\$850.00
	<b>KOCHER, Grasping forceps, atraumatic, De Bakey</b>					
	75-171-000	\$420.00	75-171-103	\$820.00	75-171-107	\$820.00
	<b>Endo-Lung Palpation forceps</b>					
	75-233-000	\$450.00	75-233-101	\$880.00	75-233-105	\$880.00
	<b>Dissecting forceps 90 curved, using with 12,5 mm trocar sleeve</b>					
	75-067-000	\$370.00	75-067-101	\$800.00	75-067-105	\$800.00
	<b>Needle holder with tungsten carbide inserts 8 mm</b>					
	75-201-000	\$420.00	75-201-107	\$830.00	75-201-147	Call For Code
	<b>Suture fixation forceps, U-shaped jaws</b>					
	75-248-000	\$370.00	75-248-107	\$420.00	75-248-147	Call For Code

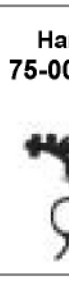
Outer Tube **330 mm 75-000-100 5mm**  
**430 mm 76-000-100 5mm**









10 mm

	Working Length	Handle 75-000-201	Handle 75-000-203	Handle 75-000-205	Handle 75-000-207	
	330 mm					
	<b>Operating scissors, large</b>					
	75-084-000	\$420.00	75-084-201	\$830.00	75-084-205	\$830.00
	<b>Spoon forceps, large</b>					
	75-180-000	\$420.00	75-180-203	\$880.00	75-180-207	\$880.00
	<b>Claw forceps 2x3 teeth</b>					
	75-179-000	\$420.00	75-179-203	\$870.00	75-179-207	\$870.00
	<b>Grasping forceps, heavy pattern</b>					
	75-225-000	\$420.00	75-225-203	\$860.00	75-225-207	\$860.00
	<b>MARYLAND, Dissecting forceps, curved</b>					
	75-074-000	\$420.00	75-074-201	\$830.00	75-074-203	\$870.00
	<b>ALLIS, Grasping forceps</b>					
	75-101-000	\$450.00	75-101-203	\$880.00	75-101-207	\$880.00
	<b>ALLIS, Grasping forceps, atraumatic, De Bakey</b>					
	75-108-000	\$4500.00	75-108-203	\$880.00	75-108-207	\$880.00
	<b>BABCOCK, Grasping forceps</b>					
	75-120-000	\$4500.00	75-120-203	\$880.00	75-120-207	\$880.00
	<b>BABCOCK, Grasping forceps, atramumatic, De Bakey</b>					
	75-123-000	\$4500.00	75-123-203	\$880.00	75-123-207	\$880.00

Outer Tube 330 mm 75-000-200 10mm













<b>10 mm</b>	Working Length	Handle 75-000-201	Handle 75-000-203	Handle 75-000-205	Handle 75-000-207	
	<b>330 mm</b>					
	<b>DUVAL, Grasping forceps</b>					
	75-176-000	\$450.00	75-176-203	\$880.00	75-176-207	\$880.00
	<b>COLLIN, Grasping forceps, atraumatic</b>					
	75-181-000	\$450.00	75-181-203	\$880.00	75-181-207	\$880.00
	<b>Dissecting-Grasping forceps, atraumatic, DeBakey</b>					
	75-080-000	\$420.00	75-080-201	\$830.00	75-080-203	\$870.00

Outer Tube **330 mm 75-000-200 10mm**







10 mm

	Jaw Length	Working Length	Handle 75-000-201	Handle 75-000-203	Handle 75-000-205	Handle 75-000-207
	Diameter	330 mm				
	<b>KOCHER, Grasping forceps, atraumatic</b>					
	50MM / 10MM	75-132-000	\$450.00	75-132-203	\$880.00	75-132-207
	60MM / 10MM	75-135-000	\$450.00	75-135-203	\$880.00	75-135-207
	<b>KOCHER, Grasping forceps, atraumatic, single DeBakey</b>					
	50MM / 10MM	75-147-000	\$450.00	75-147-203	\$880.00	75-147-207
	60MM / 10MM	75-150-000	\$450.00	75-150-203	\$880.00	75-150-207
	<b>KOCHER, Grasping forceps, atraumatic, double DeBakey</b>					
	50MM / 10MM	75-162-000	\$450.00	75-162-203	\$880.00	75-162-207
	60MM / 10MM	75-165-000	\$450.00	75-165-203	\$880.00	75-165-207
	<b>Endo-Forceps with single DeBakey, closing protection</b>					
	50MM / 10MM	75-196-000	\$450.00	75-196-203	\$880.00	75-196-207
	60MM / 10MM	75-197-000	\$450.00	75-197-203	\$880.00	75-196-207
	<b>Endo-Forceps with double DeBakey, closing protection</b>					
	50MM / 10MM	75-192-000	\$450.00	75-192-203	\$880.00	75-192-207
	60MM / 10MM	75-193-000	\$450.00	75-193-203	\$880.00	75-192-207
	<b>Endo-Lung Palpation forceps</b>					
	50MM / 10MM	75-231-000	Call For Code	75-231-203	Call For Code	75-231-207
	60MM / 10MM	75-232-000	Call For Code	75-232-203	Call For Code	75-231-207

Outer Tube 330 mm 75-000-200 10mm





5 mm

Working Length	Handle 72-000-101	Handle 72-000-103	Handle 72-000-105	Handle 72-000-107	Handle 72-000-147
330 mm					
430 mm					

	<b>Hook scissors, straight</b>					
	72-051-000	\$320.00	72-051-101	\$670.00		
	74-051-000	\$320.00	74-051-101	\$670.00		

	<b>Hook scissors, curved left</b>					
	72-053-000	\$320.00	72-053-101	\$670.00		

	<b>Peritoneal scissors, straight</b>					
	72-082-000	\$320.00	72-082-101	\$670.00		
	74-082-000	\$320.00	74-082-101	\$670.00		

	<b>Micro dissecting scissors, straight</b>					
	72-048-000	\$320.00	72-048-101	\$670.00	72-048-105	\$670.00

	<b>Micro dissecting scissors, curved left</b>					
	72-049-000	\$320.00	72-049-101	\$670.00	72-049-105	\$670.00

	<b>METZENBAUM, Dissecting scissors, straight</b>					
	72-046-000	\$320.00	72-046-101	\$670.00		

	<b>METZENBAUM, Dissecting scissors, curved</b>					
	72-047-000	\$320.00	72-047-101	\$670.00		















	<b>METZENBAUM, Dissecting scissors, straight</b>					
	72-054-000	\$320.00	72-054-101	\$670.00		
	74-054-000	\$320.00	74-054-101	\$670.00		

	<b>METZENBAUM, Dissecting scissors, curved</b>					
	72-056-000	\$320.00	72-056-101	\$670.00		
	74-056-000	\$320.00	74-056-101	\$670.00		

Outer Tube 330 mm 72-000-100 5mm  
430 mm 74-000-100 5mm









5 mm	Working Length	Handle 72-000-101	Handle 72-000-103	Handle 72-000-105	Handle 72-000-107	Handle 72-000-147
	330 mm					
	430 mm					
	<b>METZENBAUM, Dissecting scissors, straight, with teeth</b>					
	72-057-000	\$320.00	72-057-101	\$670.00		
	74-057-000	\$320.00	74-057-101	\$670.00		
	<b>METZENBAUM, Dissecting scissors, curved, with teeth</b>					
	72-059-000	\$320.00	72-059-101	\$670.00		
	74-059-000	\$320.00	74-059-101	\$670.00		
	<b>Biopsy forceps</b>					
	72-063-000	\$320.00	72-063-101	\$670.00		
	74-063-000	\$380.00	74-063-101	\$670.00		
	<b>Biopsy forceps with thorn</b>					
	72-064-000	\$320.00	72-064-101	\$670.00		
	74-064-000	\$320.00	74-064-101	\$670.00		
	<b>BLAKESLY, Biopsy forceps</b>					
	72-081-000	\$320.00	72-081-101	\$670.00		
	74-081-000	\$320.00	74-081-101	\$670.00		
	<b>Biopsy punch</b>					
	72-060-000	\$380.00	72-060-101	\$670.00		
	74-060-000	\$380.00	74-060-101	\$670.00		
	<b>Biopsy punch</b>					
	72-062-000	\$380.00	72-062-101	\$670.00		
	74-062-000	\$380.00	74-062-101	\$670.00		
	<b>Grasping forceps</b>					
	72-065-000	\$320.00	72-065-103	\$670.00		
	74-065-000	\$320.00	72-065-103	\$670.00		
	<b>Grasping forceps, fenestrated</b>					
	72-079-000	\$320.00	72-079-103	\$670.00		
	74-079-000	\$320.00	74-079-103	\$670.00		

Outer Tube 330 mm 72-000-100 5mm  
430 mm 74-000-100 5mm







5 mm

Working Length	Handle 72-000-101	Handle 72-000-103	Handle 72-000-105	Handle 72-000-107	Handle 72-000-147
330 mm					
430 mm					

	Grasping forceps, delicate pattern					
	72-066-000	\$320.00	72-066-103	\$710.00		
	74-066-000	\$320.00	74-066-103	\$710.00		

	Grasping forceps, heavy pattern					
	72-078-000	\$320.00	72-078-103	\$710.00		
	74-078-000	\$320.00	74-078-103	\$710.00		

	Grasping forceps					
	72-068-000	\$320.00	72-068-103	\$710.00		
	74-068-000	\$320.00	74-068-103	\$710.00		

	Grasping forceps, pointed					
	72-069-000	\$320.00	72-069-103	\$710.00		
	74-069-000	\$320.00	74-069-103	\$710.00		

	Grasping forceps					
	72-075-000	\$320.00	72-075-103	\$710.00		
	74-075-000	\$320.00	74-075-103	Call For Code		

	Dissecting forceps, atraumatic serration					
	72-070-000	\$320.00	72-070-101	\$670.00		
	74-070-000	\$320.00	74-070-101	\$670.00		















	MARYLAND, Dissecting forceps, curved					
	72-072-000	\$320.00	72-072-101	\$670.00		
	74-072-000	\$320.00	74-072-101	\$670.00		

	Dissecting forceps, curved 45					
	72-246-000	\$320.00	72-246-101	\$670.00	72-246-105	\$710.00
	74-246-000	\$380.00	74-246-101	\$670.00	74-246-105	\$770.00

	Dissecting forceps, curved 90					
	72-247-000	\$320.00	72-247-101	Call For Code	72-247-105	\$710.00

Outer Tube 330 mm 72-000-100 5mm  
430 mm 74-000-100 5mm









<b>5 mm</b>	Working Length	Handle 72-000-101	Handle 72-000-103	Handle 72-000-105	Handle 72-000-107	Handle 72-000-147
	330 mm					
	430 mm					
	<b>Grasping forceps, atraumatic, De Bakey, with tungsten carbide</b>					
	72-240-000	\$380.00	72-240-103	Call For Code	72-240-107	\$800.00
	<b>Grasping forceps, atraumatic, De Bakey</b>					
	72-242-000	\$380.00	72-242-103	\$800.00	72-242-107	\$800.00
	74-242-000	\$380.00	74-242-103	\$800.00	74-242-107	\$800.00
	<b>Grasping forceps</b>					
	72-077-000	\$320.00	72-077-103	\$670.00		
	74-077-000	\$320.00	74-077-103	\$670.00		
	<b>Grasping forceps 2x3 teeth</b>					
	72-076-000	\$320.00	72-076-103	\$670.00		
	74-076-000	\$320.00	74-076-103	\$670.00		
	<b>Claw forceps 2x3 teeth</b>					
	72-083-000	\$320.00	72-083-103	Call For Code	72-083-107	\$740.00
	<b>DORSEY, Grasping forceps</b>					
	72-249-000	\$320.00	72-249-103	Call For Code	72-249-107	\$770.00
	<b>Grasping forceps HI with tungsten carbide</b>					
	72-286-000	\$380.00	72-286-103	Call For Code	72-286-107	\$800.00
	74-286-000	\$380.00	74-286-103	\$770.00	74-286-107	\$800.00
	<b>ALLIS, Grasping forceps</b>					
	72-105-000	\$380.00	72-105-103	Call For Code	72-105-107	\$800.00
	<b>ALLIS, grasping forceps, atraumatic, De Bakey</b>					
	72-111-000	\$380.00	72-111-103	Call For Code	72-111-107	\$800.00

Outer Tube 330 mm 72-000-100 5mm  
430 mm 74-000-100 5mm





5 mm

Working Length	Handle 72-000-101	Handle 72-000-103	Handle 72-000-105	Handle 72-000-107	Handle 72-000-147
330 mm					
430 mm					

	<b>ALLIS, Grasping forceps, atraumatic, with tungsten carbide</b>				
72-117-000	\$380.00	72-117-103	Call For Code	72-117-107	\$800.00

	<b>KOCHER, Grasping forceps, atramatic, De Bakey</b>				
72-171-000	\$380.00	72-171-103	Call For Code	72-171-107	\$800.00

	<b>Dissecting forceps, curved</b>				
72-073-000	\$320.00	72-073-101	\$670.00		

	<b>Dissecting forceps 90 curved, using with 12,5 mm trocar sleeve</b>				
72-067-000	\$320.00	72-067-101	\$710.00		

	<b>Endo-Forceps with single De Bakey, closing protection</b>				
72-198-000	\$380.00	72-198-103	Call For Code	72-198-107	\$800.00

	<b>Endo-Lung Palpation forceps</b>				
72-233-000	\$380.00	72-233-101	Call For Code	72-233-105	\$770.00

	<b>Needle holder with tungsten carbide inserts 8 mm</b>				
72-201-000	\$380.00	72-201-147	\$380.00		













	<b>Needle holder with tungsten carbide inserts 10 mm</b>				
72-203-000	\$380.00	72-203-147	\$840.00		

	<b>Suture fixation forceps, U-shaped jaws</b>				
72-248-000	\$320.00	72-248-147	\$800.00		

Outer Tube 330 mm 72-000-100 5mm













10 mm

	Working Length	Handle 72-000-202	Handle 72-000-204	Handle 72-000-206	Handle 72-000-208	
	<b>330 mm</b>					
<b>Operating scissors, large</b>						
	72-084-000	\$380.00	72-084-202	Call For Code	72-084-206	\$740.00
	<b>Spoon forceps, large</b>					
	72-180-000	\$380.00	72-180-204	Call For Code	72-180-208	\$820.00
	<b>Claw forceps 2x3 teeth</b>					
	72-179-000	\$380.00	72-179-204	Call For Code	72-179-208	\$820.00
	<b>Grasping forceps, heavy pattern</b>					
	72-225-000	\$380.00	72-225-204	Call For Code	72-225-208	\$820.00
	<b>MARYLAND, Dissecting forceps, curved</b>					
	72-074-000	\$380.00	72-074-202	\$710.00		
	<b>ALLIS, Grasping forceps</b>					
	72-101-000	\$420.00	72-101-204	Call For Code	72-101-208	\$860.00
	<b>ALLIS, Grasping forceps, atraumatic, De Bakey</b>					
	72-108-000	\$420.00	72-108-204	Call For Code	72-108-208	\$860.00
	<b>ALLIS, Grasping forceps, atraumatic, with tungsten carbide</b>					
	72-214-000	\$420.00	72-214-204	Call For Code	72-214-208	\$860.00
	<b>BABCOCK, Grasping forceps</b>					
	72-120-000	\$420.00	72-120-204	Call For Code	72-120-208	\$860.00

Outer Tube **330 mm 72-000-200 10mm**













10 mm

	Working Length	Handle 72-000-202	Handle 72-000-204	Handle 72-000-206	Handle 72-000-208	
	330 mm					
	<b>BABCOCK, Grasping forceps, atraumatic, De Bakey</b>					
	72-123-000	\$420.00	72-123-204	Call For Code	72-123-208	\$860.00
	<b>BABCOCK, Grasping forceps, atraumatic, with tungsten carbide</b>					
	72-220-000	\$420.00	72-220-204	Call For Code	72-220-208	\$860.00
	<b>DUVAL, Grasping forceps</b>					
	72-176-000	\$380.00	72-176-204	Call For Code	72-176-208	\$820.00
	<b>COLLIN, Grasping forceps, atraumatic</b>					
	72-181-000	\$420.00	72-181-204	Call For Code	72-181-208	\$860.00
	<b>COLLIN, Grasping forceps, atraumatic, with tungsten carbide inserts</b>					
	72-074-000	\$380.00	72-074-202	\$710.00		
	<b>Dissecting-Grasping forceps, atraumatic, De Bakey</b>					
	72-080-000	\$380.00	72-080-202	\$740.00		

Outer Tube 330 mm 72-000-200 10mm





10 mm	Jaw Length	Working Length	Handle 72-000-202	Handle 72-000-204	Handle 72-000-206	Handle 72-000-208
	Diameter	330 mm				
	<b>KOCHER, Grasping forceps, atraumatic</b>					
	30MM / 10MM	72-126-000	\$420.00	72-126-204	Call For Code	72-126-208
	40MM / 10MM	72-129-000	\$420.00	72-129-204	Call For Code	72-129-208
	50MM / 10MM	72-132-000	\$420.00	72-132-204	Call For Code	72-132-208
	<b>KOCHER, Grasping forceps, atraumatic, single De Bakey</b>					
	30MM / 10MM	72-141-000	\$420.00	72-141-204	Call For Code	72-141-208
	40MM / 10MM	72-144-000	\$420.00	72-144-204	Call For Code	72-144-208
	50MM / 10MM	72-147-000	\$420.00	72-147-204	Call For Code	72-147-208
	<b>KOCHER, Grasping forceps, atraumatic, double De Bakey</b>					
	30MM / 10MM	72-156-000	\$420.00	72-156-204	Call For Code	72-156-208
	40MM / 10MM	72-159-000	\$420.00	72-159-204	Call For Code	72-159-208
	50MM / 10MM	72-162-000	\$420.00	72-162-204	Call For Code	72-162-208
	<b>Endo-Forceps with single De Bakey, closing protection</b>					
	40MM / 10MM	72-195-000	\$420.00	72-195-204	Call For Code	72-195-208
	50MM / 10MM	72-196-000	\$420.00	72-196-204	Call For Code	72-196-208
	60MM / 10MM	72-197-000	\$420.00	72-197-204	Call For Code	72-197-208
	<b>Endo-Forceps with double De Bakey, closing protection</b>					
	40MM / 10MM	72-191-000	\$420.00	72-191-204	Call For code	72-191-208
	50MM / 10MM	72-192-000	\$420.00	72-192-204	Call For Code	72-192-208
	60MM / 10MM	72-193-000	\$420.00	72-193-204	Call For Code	72-193-208
	<b>Endo-Lung Palpation forceps</b>					
	40MM / 10MM	72-230-000	\$420.00	72-230-202	Call For Code	72-230-206
	50MM / 10MM	72-231-000	\$420.00	72-231-202	Call For Code	72-231-206
	60MM / 10MM	72-232-000	\$420.00	72-232-202	Call For Code	72-232-206

Outer Tube 330 mm 72-000-200 10mm





The good results of open abdominal surgery can hardly be improved upon using the conventional techniques. Through the application of modern video-endoscopic technology and appropriate instruments, however, the trauma of operative access can be substantially reduced. Small punctures replace abdominal sections. The advantages of minimal invasive surgery are the results.

With a number of new developed instruments *Germed USA Inc.* would like to make an up-to-date contribution to laparoscopic operating techniques.

For neat preparation of the operation situs during laparoscopic operations, *GermedUSA Inc.* now offers you the ideal balanced set of instruments developed in accordance with hundreds of tried and tested examples from classic abdominal surgery.

The new *Germed USA Inc.* Endo Hook System

The Endo Hook System newly developed by *GermedUSA Inc.* is a rod-shaped instrument having a diameter of 5mm and 10mm and on whose front end an Endo hook is fixed. At the top end of the instrument a handle with an operating mechanism is mounted, allowing for infinitely variable adjustment of the respective hook, from 0 to 90 degrees. Thus, with the help of an appropriate *Germed USA Inc.* Endo hook, it is possible to achieve the same beneficial effects as with hooks used in classic abdominal surgery.

ASSEMBLED INSTRUMENT



DISASSEMBLED INSTRUMENT



Insert, with instrument tip











Handle



Outer tube with screw cap

10 mm

	Jaw Length	Working Length	Handle 72-000-159	Handle 72-000-260		
	Diameter	330 mm				
	<b>Endo-Retractor Kocher-Langenbeck</b>					
	30MM / 10MM	77-001-000	\$650.00	77-001-159	\$920.00	
	40MM / 10MM	77-002-000	\$650.00	77-002-159	\$920.00	
	50MM / 10MM	77-003-000	\$650.00	77-003-159	\$920.00	
	30MM / 10MM	77-011-000	\$650.00	77-011-260	\$930.00	
	40MM / 10MM	77-012-000	\$650.00	77-012-260	\$930.00	
	50MM / 10MM	77-013-000	\$650.00	77-013-260	\$930.00	
	<b>Endo-Retractor Cushing</b>					
	30MM / 10MM	77-015-000	\$690.00	77-015-260	\$990.00	
	40MM / 10MM	77-016-000	\$690.00	77-016-260	\$990.00	
	50MM / 10MM	77-017-000	\$690.00	77-017-260	\$990.00	
	<b>Endo-Retractor fan-shaped</b>					
	50MM / 5MM	77-021-000	\$600.00	77-021-159	\$900.00	
	60MM / 5MM	77-022-000	\$600.00	77-022-159	\$900.00	
	50MM / 10MM	77-023-000	\$600.00	77-023-260	\$900.00	
	60MM / 10MM	77-024-000	\$600.00	77-024-260	\$900.00	
	<b>Endo-Esophageal-Retractor/Dissector</b>					
	35MM / 5MM	77-030-000	\$680.00	77-030-159	\$930.00	
	35MM / 10MM	77-031-000	\$680.00	77-031-260	\$950.00	
	<b>Endo-Esophageal-Retractor/Dissector</b>					
	35MM / 10MM	77-032-000	\$720.00	77-032-260	\$980.00	
	<b>Endo-Laparolifter (in conjunction with CO2 insufflation)</b>					
	40MM / 10MM	77-052-000	\$600.00	77-052-260	\$940.00	

Outer Tube 330 mm 72-000-200 10mm  
330 mm 72-000-100 5mm



10 mm

	Jaw Length	Working Length	Handle 72-000-260			
	Diameter	330 mm				

	<b>Endo-Eccentric "Y" Retractor</b>					
	40-60MM / 10MM	72-600-000 R	\$720.00	72-600-260 R	\$1,60.00	

	<b>Endo-Eccentric "Y" Retractor</b>					
	60-40MM / 10MM	72-600-000 L	\$720.00	72-600-260 L	\$1,60.00	

	<b>Endo-Eccentric "Y" Retractor</b>					
	60-60MM / 10MM	72-600-000 S	\$720.00	72-600-260 S	\$1,60.00	

Outer Tube

330 mm 72-000-200 10mm



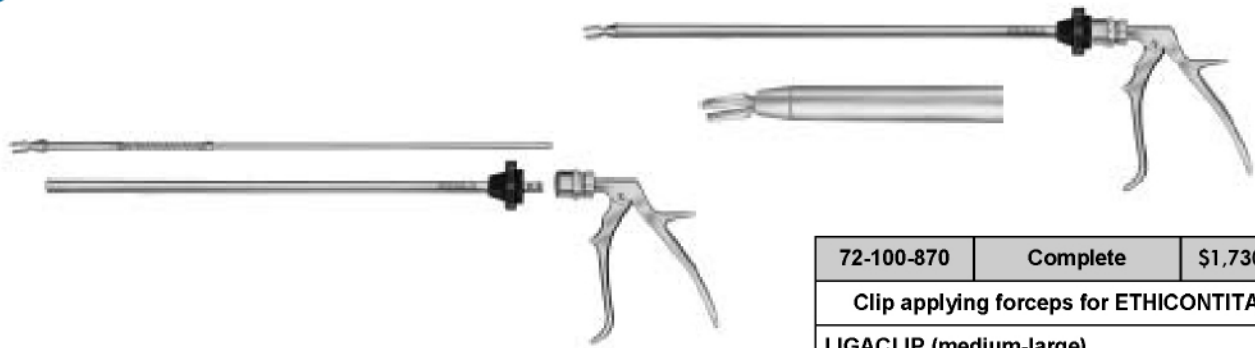

72-100-870	Complete	\$1,730.00
<b>Clip applying forceps for ETHICONTITAN</b>		
<b>LIGACLIP (medium-large)</b>		
consisting of:		
72-100-000	Insert, forceps	Call For Code
72-100-800	Outer tube 10 mm	Call For Code
72-100-070	Handle	Call For Code
Further forceps Inserts, on request		
78-00500	\$70.00	



Applicator for endo-ligature, 5mm



78-00501	\$170.00
----------	----------

Knot-sliding instrument, 5mm



78-00502	\$180.00
----------	----------

Knot guide for extracorporeal knotting, 5mm  
(only useable with applicator 78-00500)



78-00503	\$130.00
----------	----------

Knot guide for extracorporeal knotting, 5mm  
(only useable with applicator 78-00500)

Endoscope and Instrument Holder	
72-700-000	fully autoclavable
components:	
Germated Articulating post # -3800-40	
(400 mm) fixed with the handle	
Endoscope and Instrument Holder 10 mm	
Thread base on rails 25x10 and 35x8 mm	
Support 300 mm, adjustment of height	





Cleaning Brush, 500 mm length		
79-00011	for Outer tube 5 mm insulated / metal and Outer tube 10 mm insulated	\$16.00
79-00012	for Outer tube 10 mm metal	\$16.00



Instrument Oil P-102		
79-00010	50 ml	\$60.00

**Handles for rotating and detachable  
5 mm and 10 mm Instruments:**



72-000-101	5 mm	\$220.00
72-000-202	10 mm	Call For Code
with HF-connector		
without ratchet		



72-000-103	5 mm	\$260.00
72-000-204	10 mm	Call For Code
with HF-connector		
with ratchet		



72-000-105	5 mm	\$260.00
72-000-206	10 mm	Call For Code
without ratchet		



72-000-107	5 mm	\$300.00
72-000-208	10 mm	Call For Code
with ratchet		



72-000-109	5 mm	Call For Code
72-000-210	10 mm	Call For Code
metal spring action		

**Handles for detachable  
5 mm and 10 mm Instruments:**



72-000-121	5 mm	Call For Code
72-000-222	10 mm	Call For Code
with HF-connector		
without ratchet		



72-000-123	5 mm	Call For Code
72-000-224	10 mm	Call for Code
with HF-connector		
with ratchet		



72-000-125	5 mm	Call For Code
72-000-226	10 mm	Call for Code
without ratchet		



72-000-127	5 mm	Call for code
72-000-228	10 mm	Call for Code
with ratchet		



72-000-129	5 mm	Call For Code
72-000-230	10 mm	Call For Code
metal spring action		



**Handles for rotating and detachable  
5 mm and 10 mm Instruments:**



72-000-141	5 mm	Call For Code
72-000-242	10 mm	Call For Code
without ratchet		
72-000-143	5 mm	Call for Code
72-000-244	10 mm	Call for Code
with ratchet		

**Handles for detachable  
5 mm and 10 mm Instruments:**



72-000-145	5 mm	Call for Code
72-000-246	10 mm	Call for Code
without ratchet		
72-000-147	5 mm	Call for Code
72-000-248	10 mm	Call For Code
72-000-159	5 mm	Call for code
72-000-260	10 mm	Call For Code



**Spare Parts**



72-000-100	5 mm	Outer tube insulated	\$160.00
72-000-300	5 mm	Outer tube metal	Call for Code

Outer tube with screw cap for 5 mm Instruments



72-000-200	10 mm	Outer tube insulated	Call For Code
72-000-400	10 mm	Outer tube metal	Call For Code

Outer tube with screw cap for 10 mm Instruments

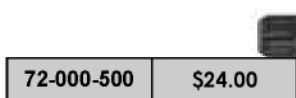

Screw cap for 5 mm Instruments

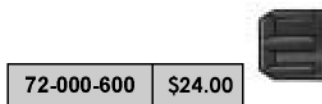

Screw cap for 10 mm Instruments

ASSEMBLED INSTRUMENT

5 mm x 340 mm



DISASSEMBLED INSTRUMENT

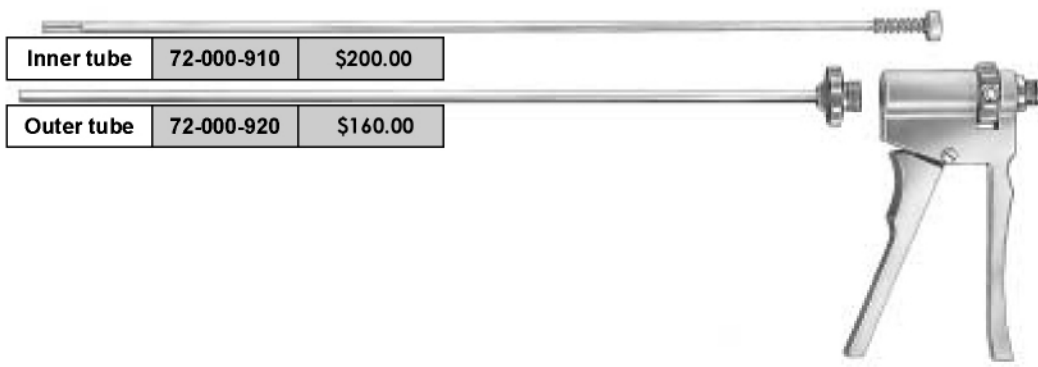

Inner tube	72-000-910	\$200.00
------------	------------	----------

Outer tube	72-000-920	\$160.00
------------	------------	----------

Handle	
72-000-980	\$690.00



72-210-980	Complete	\$1,300.00
<b>Bipolar Forceps 1 mm, complete,</b>		
consisting of:		
72-210-000	Insert forceps	\$300.00
72-000-920	Outer tube 5 mm	\$160.00
72-000-910	Inner tube	\$200.00
72-000-980	Handle	\$690.00



72-211-980	Complete	\$1,300.00
<b>Bipolar Forceps 3 mm, complete,</b>		
consisting of:		
72-211-000	Insert forceps	\$300.00
72-000-920	Outer tube 5 mm	\$160.00
72-000-910	Inner tube	\$200.00
72-000-980	Handle	\$690.00

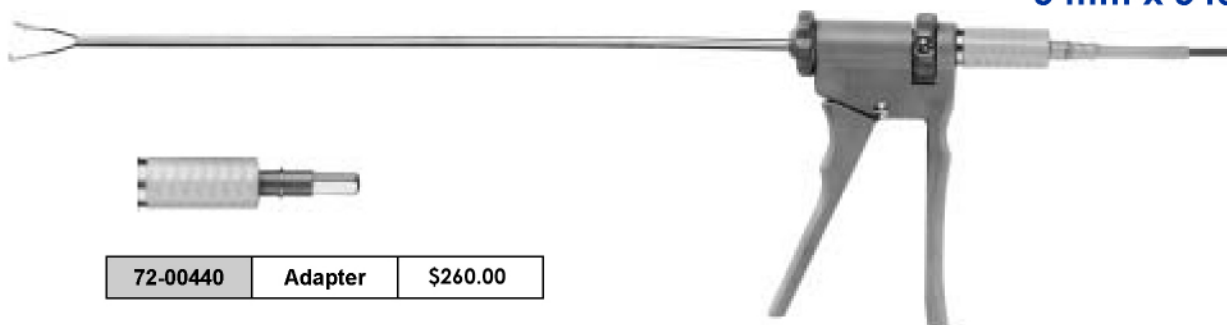

72-00440	Adapter	\$260.00
----------	---------	----------



72-212-980	Complete	\$1,300.00
<b>Bipolar Forceps complete,</b>		
consisting of:		
72-212-000	Insert forceps	\$300.00
72-000-920	Outer tube 5 mm	\$160.00
72-000-910	Inner tube	\$200.00
72-000-980	Handle	\$690.00



72-213-981	Complete	\$1,760.00
<b>Bipolar Scissors complete,</b>		
consisting of:		
72-213-000	Insert forceps	\$660.00
72-000-920	Outer tube 5 mm	\$160.00
72-000-910	Inner tube	\$200.00
72-000-081	Handle	Call For code

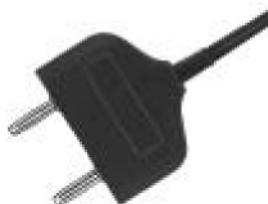

72-00400
Valleylab-Plug



72-00420	\$260.00
Erbe-Plug	



72-00410
Codman-Plug



72-00430	\$220.00
Martin/Berchtold-Plug	

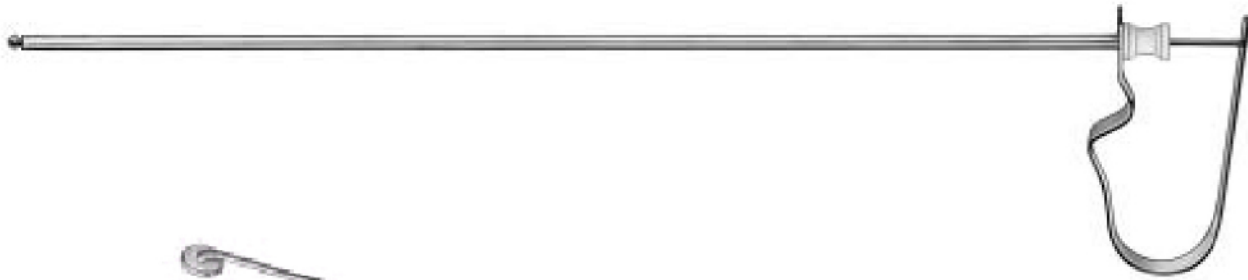

78-00200	\$240.00
----------	----------

Bowel Forceps



78-00201	\$240.00
----------	----------

Atraumatic Grasping forceps



78-00202	\$240.00
----------	----------

Fimbrial Holding Forceps, t-pattern



78-00203	\$240.00
----------	----------

Fimbrial Holding Forceps, square pattern



78-00204	\$260.00
----------	----------

Fimbrial Holding Forceps, ring pattern



78-00205	\$300.00
----------	----------

Swab Grasper

With the detachable instruments *GermedUSA Inc.* introduces the latest generation of laparoscopic instruments, which can be easily disassembled for a thorough, so far not possible, cleaning. Through the unique constructional conception, it is also possible, that the interchangeable basic elements of each instrument can be combined with various handles.

In case of erosion of the instruments' insert, it can be replaced by a new one. This leads to a clear lowering of costs, as only the instruments insert has to be exchanged and not the complete instrument.

The detachable *GermedUSA Inc.* instruments offer therefore best possible protection against infection, and they are user-friendly through an easy disassembly and the combination of the instrument inserts with various handles. As the basic elements like handle and instrument insert can be ordered separately they are cost lowering. These instruments offer a clearly improved cost-use relation.

#### ASSEMBLED INSTRUMENT

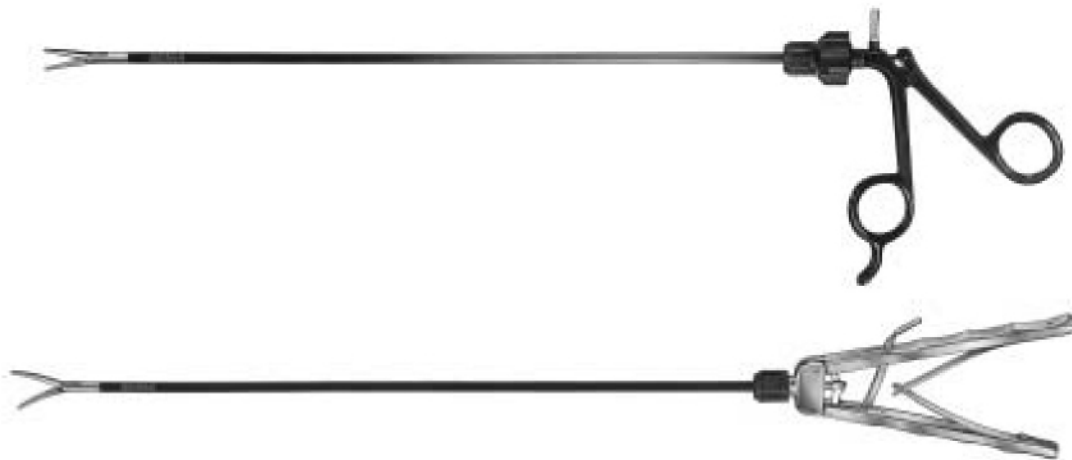

#### DISASSEMBLED INSTRUMENT



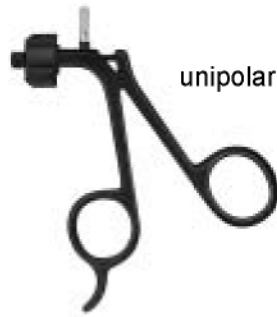

74-051-101	Complete	\$670.00
<b>Hook Scissors, Straight</b>		
consisting of:		
74-051-000	Insert, scissors	\$320.00
74-000-100	Outer tube, 5 mm	\$160.00
72-000-101	Handle with HF-connector	\$160.00



**METZENBAUM**

74-056-101	Complete	\$670.00
<b>Dissecting Scissors, Curved</b>		
consisting of:		
74-056-000	Insert, scissors	\$320.00
74-000-100	Outer tube, 5 mm	\$160.00
72-000-101	Handle with HF-connector	\$220.00



74-064-101	Complete	\$670.00
<b>Biopsy Forceps with Thorn</b>		
consisting of:		
74-064-000	Insert, Biopsy Forceps	\$320.00
74-000-100	Outer tube, 5 mm	\$160.00
72-000-101	Handle with HF-connector	\$220.00



**BLAKESLY**

74-081-101	Complete	\$670.00
<b>Biopsy Forceps</b>		
consisting of:		
74-081-000	Insert, Biopsy Forceps	\$320.00
74-000-100	Outer tube, 5 mm	\$160.00
72-000-101	Handle with HF-connector	\$220.00

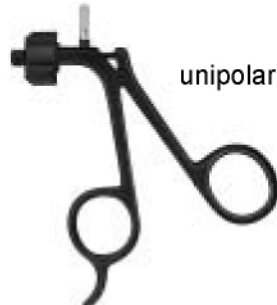

74-060-101	Complete	\$670.00
<b>Biopsy Punch</b>		
consisting of:		
74-060-000	Insert, Biopsy Punch	\$380.00
74-000-100	Outer tube, 5 mm	\$160.00
72-000-101	Handle with HF-connector	\$220.00



5 mm x 430 mm



74-062-101	Complete	\$670.00
<b>Biopsy Punch</b>		
consisting of:		
74-062-000	Insert, Biopsy Punch	\$380.00
74-000-100	Outer tube, 5 mm	\$160.00
72-000-101	Handle with HF-connector	



74-065-103	Complete	\$220.00
<b>Grasping Forceps</b>		
consisting of:		
74-065-000	Insert, Grasping Forceps	\$320.00
74-000-100	Outer tube, 5 mm	\$160.00
72-000-103	Handle with HF-connector and ratchet	Call For Code



74-078-103	Complete	\$710.00
<b>Grasping Forceps, Atraumatic, De Bakay</b>		
consisting of:		
74-078-000	Insert, Grasping Forceps	\$320.00
74-000-100	Outer tube, 5 mm	\$160.00
72-000-103	Handle with HF-connector and ratchet	\$260.00



74-242-107	Complete	\$800.00
<b>Grasping Forceps, Atraumatic, De Bakay</b>		
consisting of:		
74-242-000	Insert, Grasping Forceps	\$380.00
74-000-100	Outer tube, 5 mm	\$160.00
72-000-107	Handle with ratchet	\$710.00



74-076-103	Complete	\$710.00
<b>Grasping Forceps 2 x 3 Teeth</b>		
consisting of:		
74-076-000	Insert, Grasping Forceps	\$320.00
74-000-100	Outer tube, 5 mm	\$160.00
72-000-103	Handle with HF-connector and ratchet	Call For Code

ASSEMBLED INSTRUMENT



DISASSEMBLED INSTRUMENT

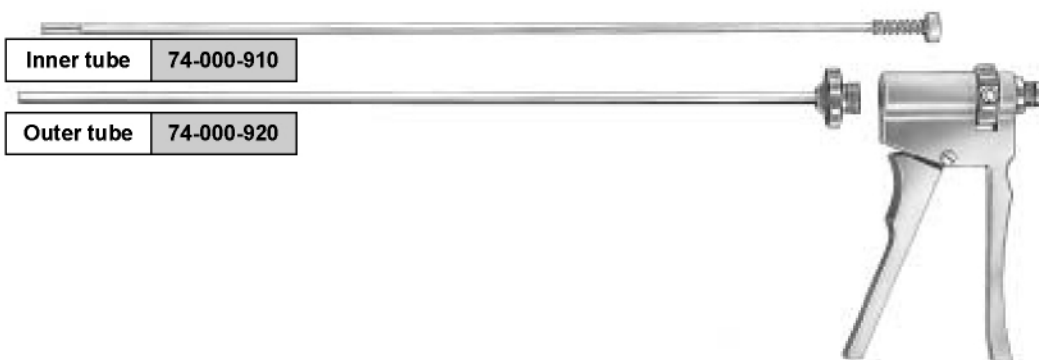

Inner tube 74-000-910

Outer tube 74-000-920

Handle	
72-000-980	\$690.00



74-210-980	Complete	\$1,400.00
<b>Bipolar Forceps 3 mm, complete</b>		
consisting of:		
74-210-000	Insert forceps	\$360.00
74-000-920	Outer tube, 5 mm	\$180.00
74-000-910	Inner tube	\$210.00
72-000-980	Handle	\$690.00



74-211-980	Complete	\$1,400.00
<b>Bipolar Forceps 3 mm, complete</b>		
consisting of:		
74-211-000	Insert forceps	\$350.00
74-000-920	Outer tube, 5 mm	\$180.00
74-000-910	Inner tube	\$210.00
72-000-980	Handle	\$690.00

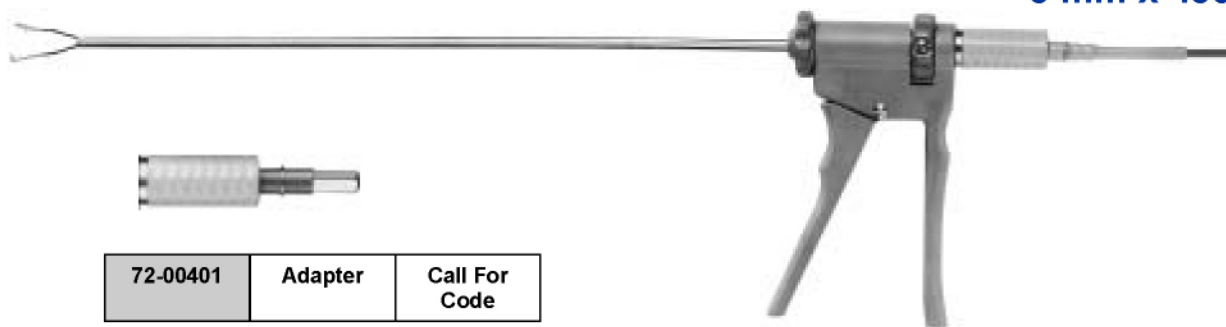

72-00401	Adapter	Call For Code
----------	---------	---------------



72-212-980	Complete	\$1,300.00
Bipolar Forceps complete,		
consisting of:		
72-212-000	Insert forceps	\$300.00
72-000-920	Outer tube 5 mm	\$160.00
72-000-910	Inner tube	\$200.00
72-000-980	Handle	\$690.00



72-213-981	Complete	\$1,770.00
Bipolar Scissors complete,		
consisting of:		
72-213-000	Insert forceps	\$710.00
72-000-920	Outer tube 5 mm	\$160.00
72-000-910	Inner tube	\$200.00
72-000-081	Handle	Call For Code



72-00400	\$390.00
Valleylab-plug	



72-00420	\$260.00
Erbe-plug	



72-00410	\$310.00
Codman-plug	



72-00430	\$420.00
Martin/Berchtold-plug	