

GerVetUSA™
Animal Care at the Highest Quality

A Division of



If we don't have the instrument
you are looking for
we will MANUFACTURE it for you.

VETERINARY SURGICAL INSTRUMENT GUIDE

Small Animal, General Surgery,
& Orthopedic Instruments

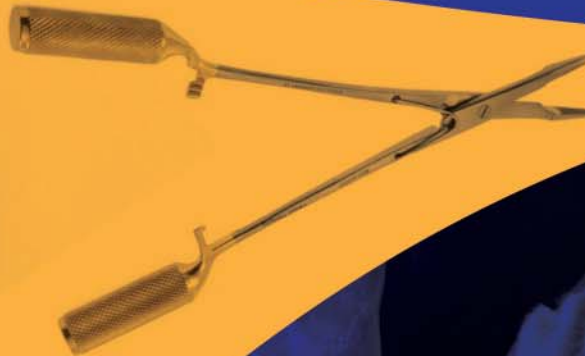
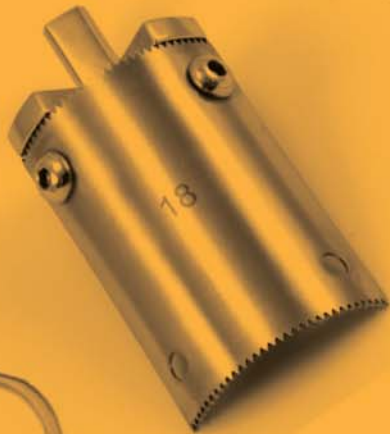

2417 JERICHO TURNPIKE, #333, GARDEN CITY PARK, NY 11040 (USA) | www.GerVetUSA.com
TEL: 800.330.1322 | 516.358.2180 FAX: 800.260.7177 | 516.358.2182 EMAIL: sales@GerMedUSA.com

GerVetUSA

All **GerMedUSA** surgical instruments are guaranteed for life against manufacturing defects, provided that the instrument is used for its intended surgical purpose. **GerMedUSA** will either repair or replace the instrument without charge at our discretion*. Our liability under this guarantee shall be limited to repair or replacement of defective merchandise. Our guarantee is unqualified because our own quality control inspectors check **GerMedUSA** surgical instruments.

- * Our instruments are carefully examined by our surgical instrument experts.
- * No instrument is shipped unless it meets our standards.
- * Tungsten carbide instruments are included except for jaw inserts and Gold handles by a separate warranty.

GerMedUSA not only offers Veterinarians quality products but also services that meet the demands of today's growing veterinarian practice. Offering a complete line of specialty, general and premium instruments that complement the routine to dental and surgical procedures

© www.GerVetUSA.com
2005-2012. All Rights Reserved.
2417 JERICHO TURNPIKE, #333,
GARDEN CITY PARK, NY 11040 (USA)
TEL: 800.330.1322 | 516.358.2180
FAX: 800.260.7177 | 516.358.2182
eMAIL: sales@GerMedUSA.com



G47-118
Cooley Vascular Tissue Forceps,
tips 2mm wide, 6"

G47-120
Cooley Vascular Tissue Forceps,
tips 2mm wide, 8"



G47-100
Debakey Thoracic Tissue Forceps,
2.5mm wide Tips, 6"



G47-115
Debakey Tissue Forceps,
Atraumatic Jaws, 2.0mm, 6.25"

G47-117
Debakey Tissue Forceps,
Atraumatic Jaws, 2.0mm, 7.75"

G47-119
Debakey Tissue Forceps,
Atraumatic Jaws, 2.0mm, 9.5"

G47-121
Debakey Tissue Forceps,
Atraumatic Jaws, 3.5mm, 6.25"

G47-123
Debakey Tissue Forceps,
Atraumatic Jaws, 3.5mm, 7.75"

G47-125
Debakey Tissue Forceps,
Atraumatic Jaws, 3.5mm, 9 1/2"



G47-116
Debakey Adson Tissue Forceps,
4 3/4", 1.5 mm tips

Atraumatic Forceps



G47-188
Debakey Vascular Clamp for Aortic
Aneurism, slightly curved jaws 7.5
cm, Size 10"

G47-190
Debakey Vascular Clamp for Aortic
Aneurism, slightly curved jaws 8.5
cm, Size 10 1/2"

G47-192
Debakey Vascular Clamp for Aortic
Aneurism, slightly curved jaws 10
cm, Size 12 1/4"

G47-194
Debakey Vascular Clamp for Aortic
Aneurism, slightly curved jaws 12
cm, Size 12 3/4"

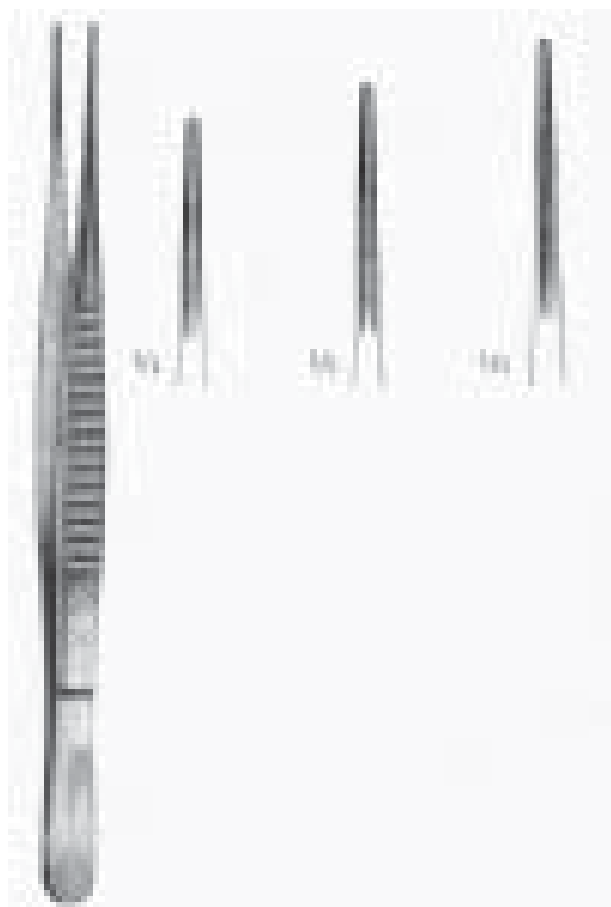

G47-108
Debakey Vascular Tissue For-
ceps, 1.5mm wide Tips, 6"

G47-112
Debakey Vascular Tissue For-
ceps, 1.5mm wide Tips, 8"

G47-114
Debakey Vascular Tissue For-
ceps, 1.5mm wide Tips, 9 1/2"



GD50-123
Heidbrink Root Tip Pick, Del H1,
Delicate, Straight, 5 1/4"

GD50-126
Heidbrink Root Tip Pick, Del H2-
3, Delicate, Double Ended, 7 3/4"



GD50-125
Heidbrink Root Tip Pick, Del
H3, Delicate, Left, 5 1/4"



GD50-124
Heidbrink Root Tip Pick, Del H3,
Delicate, Right, 5 1/4"

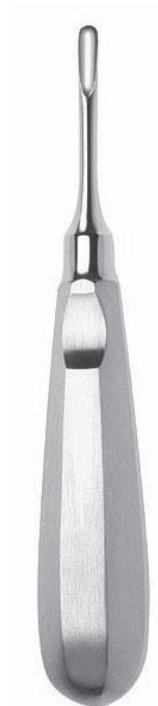

GD50-113
Root Elevator, Crane Pick, DEL
34

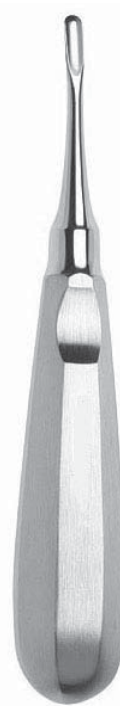

GD50-114
Root Elevator, Crane Pick, DEL
34S

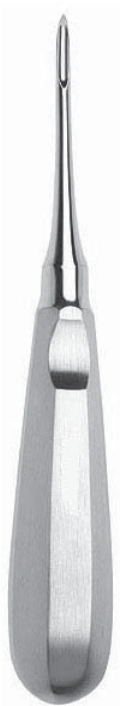

GD50-115
Root Elevator, Crane Pick,
DEL46 Elevator



GD50-10-3
Root Elevators, Apical, DEL 301

Dental Elevators



GD50-101
Root Elevators, Apical, DEL
302HF



GD50-102
Apical Del 303 Elevator, 5 3/4"



GD50-120
Root Elevators, DEL 78

GD50-627
Root Tip Elevator, Del 79,
Curved Right, 5 1/2"
GD50-629
Root Tip Elevator, Del 80,
Curved Left, 5 1/2"

Dental Elevators



GD50-501
Winged Tip Elevator with
removeable handle, 2mm, 4
3/4"

GD50-502
Winged Tip Elevator with
removeable handle, 3mm, 4
3/4"

GD50-503
Winged Tip Elevator with
removeable handle, 4mm, 4
3/4"

GD50-504
Winged Tip Elevator with
removeable handle, 5mm,
4 3/4"

GD50-505
Winged Tip Elevator with
removeable handle, 6mm, 4
3/4"

GD50-506
Winged Tip Elevator with
removeable handle, 7mm,
4 3/4"

GD50-507
Winged Tip Elevator with
removeable handle, 8mm,
4 3/4"



G40-09
Luxating Elevator, Curved Tip
2mm, 5 3/4"

G40-13
Luxating Elevator, Straight Tip
2mm, 5 3/4"

G40-10
Luxating Elevator, Curved Tip
3mm, 5 3/4"

G40-14
Luxating Elevator, Straight Tip
3mm, 5 3/4"

G40-11
Luxating Elevator, Curved Tip
4mm, 5 3/4"

G40-15
Luxating Elevator, Straight Tip
4mm, 5 3/4"

G40-12
Luxating Elevator, Curved Tip
5mm, 5 3/4"

G40-16
Luxating Elevator, Straight Tip
5mm, 5 3/4"

Dental Extracting Forceps

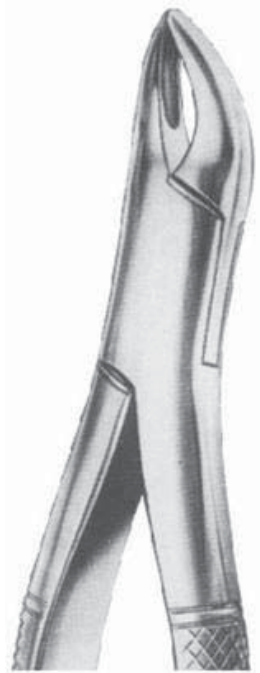

GD50-1218
Dental Extracting Forceps
Universal, Witzel, DEF116



GD50-1219
Dental Extracting Forceps
Universal, Witzel, DEF120



GD50-12
Dental Extracting Forceps, 1st
and 2nd Molar, Left, 18L



GD50-70
Dental Extracting Forceps, A,
Pedo Upper Molar, Universal, Mini



GD50-51
Standard Extracting Forceps #1

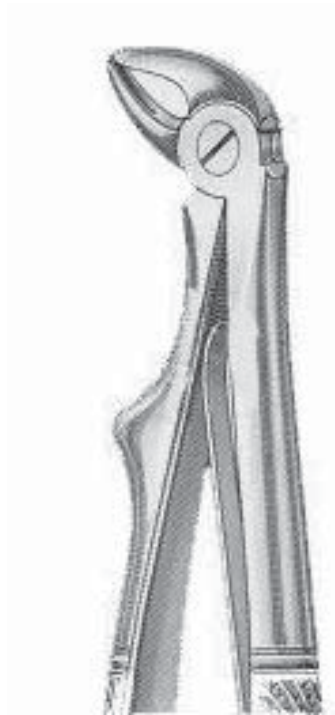

GD50-71
Dental Extracting Forceps, B,
Pedo Lower Root, Universal, Mini



GD50-73
Dental Extracting Forceps, E,
Pedo Upper Front, Mini

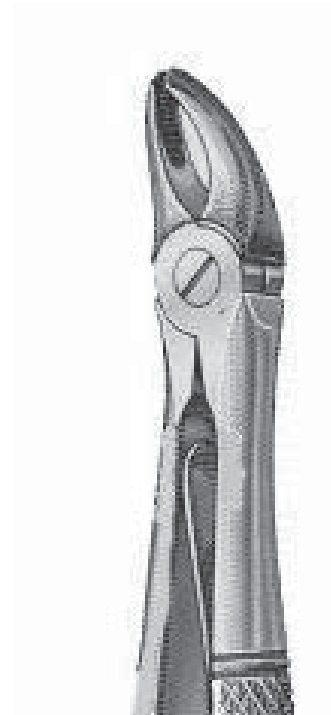

GD50-74
Dental Extracting Forceps, F,
Pedo Upper Root, Universal, Mini



GD50-41
Dental Extracting Forceps,
Lower Incisors, Cuspids, and Bi-
cuspids and Roots, Universal, 151



GD50-47
Dental Extracting Forceps,
Upper and Lower Bicuspids and
Deciduous, Universal, 101



GD50-49
Dental Extracting Forceps,
Upper and Lower Fragments and
Roots, 69

Dental Extracting Forceps



GD50-48
Dental Extracting Forceps,
Upper and Lower Splitting
and Separating, 6

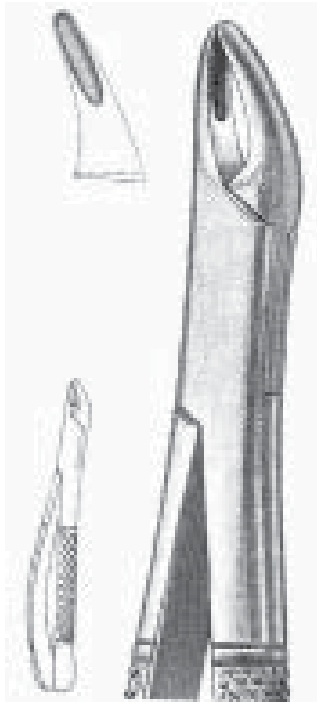

GD50-39
Dental Extracting Forceps,
Upper Anteriors, Split Beaks,
Serrated, 150AS

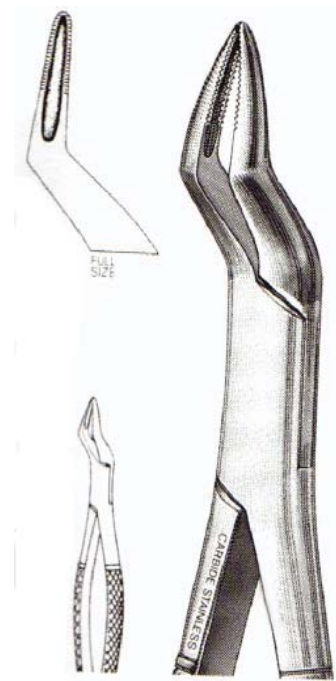

GD50-40
Dental Extracting Forceps,
Upper Bicuspid, Incisors and
Roots, 286



GD50-37
Dental Extracting Forceps,
Upper Incisors, Cuspids and
Bicuspid and Roots, Universal,
150



GD50-34
Dental Extracting Forceps,
Upper Incisors, Henahan, 1HEN

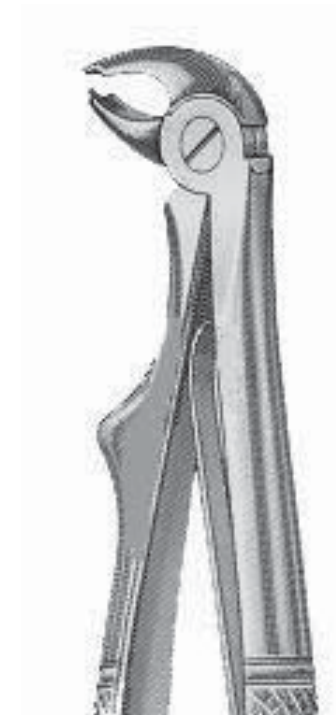

GD50-72
Dental Extracting Forceps, C,
Pedo Lower Molars, Universal,
Mini

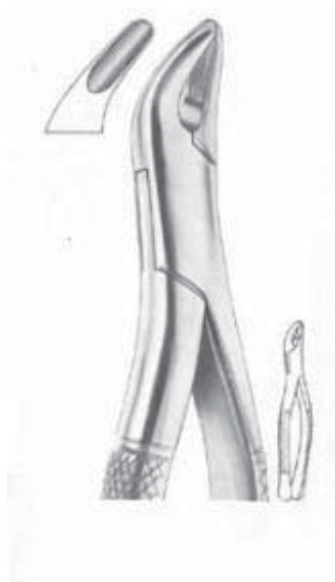

GD50-46
Dental Standard Extracting
Forceps #62



GD50-61
Universal Extracting Forceps
175



GD50-66
Universal Extracting Forceps,
150S



GD50-67
Universal Extracting Forceps,
151S

Dental Explorers



GD50-301
Dental Explorer 2D



GD50-301-1
Dental Explorer and Graduated
Probe, D/E style PE1-23

Dental Explorer



GD50-303
Dental Explorer, 17



GD50-300
Dental Explorer, Style 7



GD50-304
Dental Explorer, style 3A



GD50-133
Elevator, Periosteal, Molt, DEL
M9



GD50-1523
Excavator Style #33L



GD50-1520
Excavator Style #38/39

Dental Explorer



GD50-1521
Excavator Style #61/62



GD50-735
Probe 20-23 Explorer TT DE

Dental Rongeur

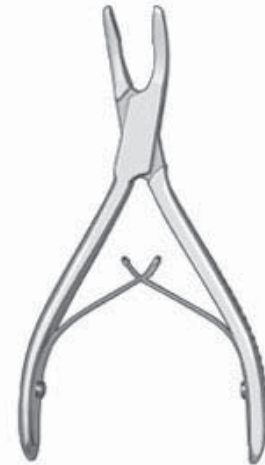

GD50-150
Friedman Dental Rongeur 5 1/2",
Curved & Delicate

Dental Scrapers & Chisels



GD50-399
Hirschfeld File, 5-11
GD50-400
Hirschfeld File, 3-7
GD50-401
Hirschfeld File, 9-10

GD50-1525
Ochsenbein Chisel #1
GD50-1526
Ochsenbein Chisel #2

GD50-1524
Ochsenbein Chisel 4

Dental Scrapers & Chisels

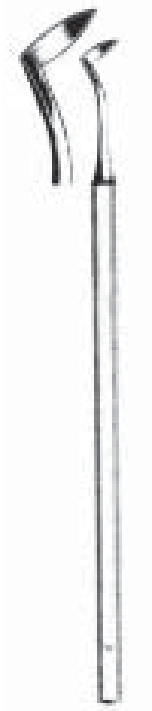

GD206-101
Scraper, Angular Point



GD206-10
Scraper, Curved, with Straight
Edge



GD206-103
Scraper, Curved, With Angled
Edge



GD206-104
Scraper, Double End, Curved,
With Angled Edges



GD206-102
Scraper, Triangle

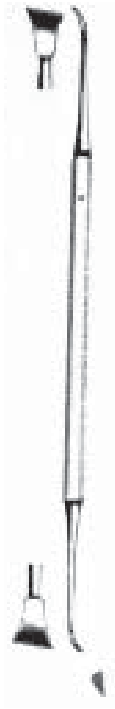

GD206-09
Tartar Scraper, Claw Type



G-206-09
Tartar Scraper D/E, Curved,
Angled, style #12

Dental Scissors



G18-280
Vannas After-Cataract Scissors,
3 1/8", Straight

G18-282
Vannas Scissors, Angled on Flat,
3"

Dental Mouth Gags

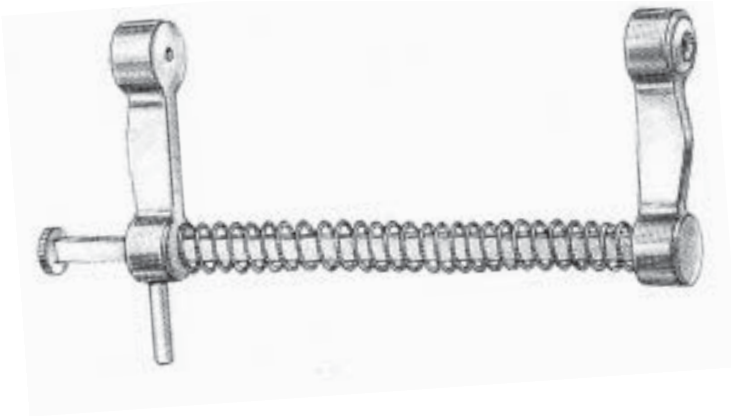

G90-900
Canine Mouth Gag Small Size 4"

G90-905
Canine Mouth Gag Medium Size 5
3/4"

G90-910
Canine Mouth Gag Large Size 6 3/4"

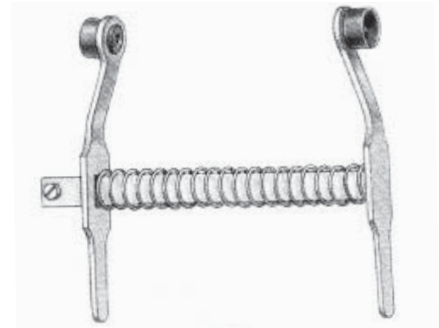

G90-890
Feline Petite Mouth Gag
Light Weight 2 1/4"

G90-895
Feline Mouth Gag Light

Dental Mirrors



GD50-593
Mirror Handle Cone Socket/
Mirror #4



GD50-616
Autoclavable Front Surface
Fiberglass Mirror, #4 and 5
White, 10/box

Dental Mirrors



G21-06-0
Dental Laryngeal Mirror
Size 0, 12mm



G21-06-01
Dental Laryngeal Mirror
Size 1, 14mm



G21-06-02
Dental Laryngeal Mirror
Size 2, 16mm



G21-06-03
Dental Laryngeal Mirror
Size 3, 18mm



G21-06-04
Dental Laryngeal Mirror Size 4,
20mm



G21-06-05
Dental Laryngeal Mirror Size
5, 22mm



G21-06-06
Dental Laryngeal Mirror Size 6,
26mm

Dental Mirrors

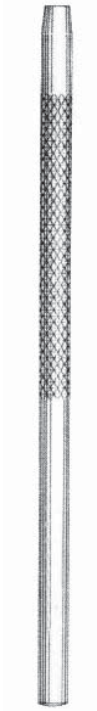

GD50-614
Deluxe Mirror Handle Cone
Socket

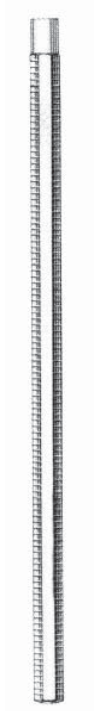

GD50-612
Octagonal Mirror Handle,
Cone socket

Dental Scalers



G206-08
Scaler, Jacquette H 6/7



GD50-789
Jacquette Scaler, 20/33



GD50-790
Jacquette Scaler, 33/H5



GD50-775
Jacquette Scaler, Double Ended, 1Y/1Y



GD50-779
Jacquette Scaler, Double Ended, 2/3

Dental Scalers



GD50-781
Jacquette Scaler, Double
Ended, 2S/3S



GD50-777
Jacquette Scaler, Double Ended,
2Y/3Y



GD50-774
Jacquette Scaler, Single Ended,
U-15

Dental Bone Curettes



GD50-810
Morse Scaler 0-00



GD50-203
Lucas Bone Curette, No.87



GD50-201
Lucas Bone Curette, No. 85

Dental Bone Curettes



GD50-202
Lucas Bone Curette, No. 86

Dental Curettes



GD50-758
Curette Columbia 13-14 Fine
TTDE, Double Ended



GD50-757
Curette Columbia 4L-4R TTDE,
Double Ended



GD50-796
Orban Knife 1-2



GD50-754
Gracey Curettes 9/10,
Double Ended



GD50-755
Gracey Curettes 11/12,
Double Ended



GD50-756
Gracey Curettes 13/14,
Double Ended



GD50-157
Gracey Curettes G 1/2,
Double Ended



GD50-751
Gracey Curettes 3/4, Double
Ended



GD50-752
Gracey Curettes 5/6, Double
Ended



GD50-813
Gracey Curettes 11/14
GD50-820
Gracey Curettes 12/13

GD50-811
Gracey Curettes 15/16
GD50-812
Gracey Curettes 17/18

Dental Currettes



GD50-777-1
Curette Style H6/7



GD50-310
McCalls Curette, Style 17/18
GD50-311
McCalls Curette, Style 11/14

Dressing & Tissue Forceps

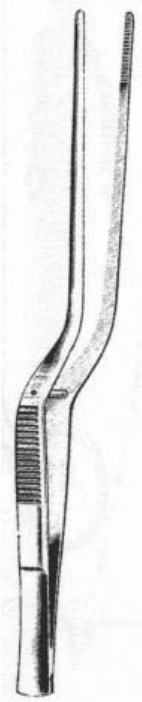

G46-290
Adson Bayonet Dressing
Forceps, Serrated, 8 1/4"



G12-21
Adson Dressing Forceps 4 3/4"
Serrated
G12-22
Adson Forceps 4 3/4" 1x2th



G12-21D
Adson Dressing Forceps,
Delicate, Serrated Jaws 4 3/4"



G12-56
Adson Forceps 4 3/4"
Micro With 1x2th



G12-55
Adson Forceps 4 3/4"
Micro With Serrations



G12-304
Adson Tissue and Suture
Forceps, 4 3/4", 1x2 teeth
with tying platform.



G17-123
Adson Tissue Forceps, 1x2
with Carbide Suture Platform,
4.75"



G12-302
Adson Tissue Forceps,
2x3 Teeth Delicate, 4 3/4"

Dressing & Tissue Forceps



G17-56
Adson Tissue Forceps, Cross
Serrated Atraumatic Carbide
Grip, 4.75"



G12-121
Adson-Brown Forceps, 9x9
teeth, side grasp, 4 3/4"



G12-26
Brown-Adson Side Grasping
Forceps, 4 3/4", 7X7th



G12-310
Brown-Adson Tissue Forceps,
7x7 side grasping teeth, angular,
4 3/4"



G11-59
Allis Adair Tissue Forceps,
9X10 Teeth, 6"



G11-154
Allis-Willauer Tissue Forceps,
5X6 Teeth, 10"



G11-98
Allis Tissue Forceps, 3X4
Teeth, 6"

G11-20
Allis Tissue Forceps, 4X5
Teeth, 6"

G11-21
Allis Tissue Forceps, 5X6
Teeth, 6"

G11-198
Allis Tissue Forceps 4x5th 7
1/2"

G11-46
Allis Tissue Forceps, 5X6
Teeth, 7 1/2"



G11-152
Baby Allis Tissue Forceps
5" Extra Delicate

G11-153
Baby Allis Tissue Forceps
5 1/2" Delicate



G18-148
Bishop Harmon Dressing Forceps 1 x 2th, 3
1/4"

G18-150
Bishop Harmon Dressing Forceps 3 1/4"
1x2th, Delicate

G18-151
Bishop Harmon Dressing Forceps, Serr, 3 3/8"



G10-507
Beasley Babcock Tissue Forceps,
Cross Points, 4 3/4"

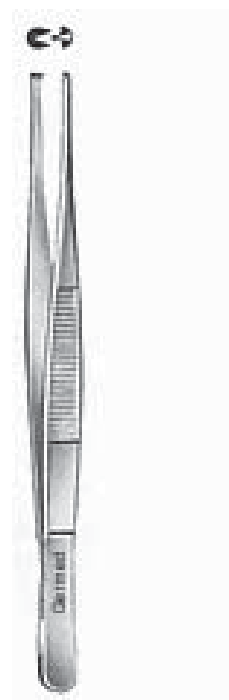

G12-15
Bonney Tissue Forceps, 1X2
Teeth, 7"

Dressing & Tissue Forceps

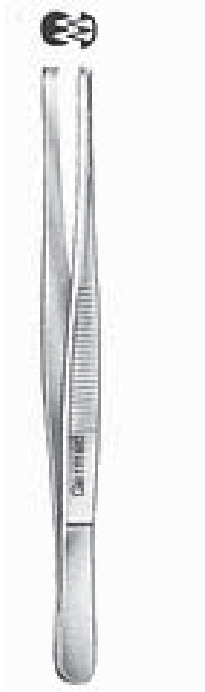

G12-14
Bonney Tissue Forceps, 2x3
Teeth, 7"



G12-201
Brown Tissue Forceps, double
rows of 8x8 teeth, Size 6"



G18-126
Eye Dressing Forceps 4" Serr

G18-128
Eye Dressing Forceps, 4" Heavy

G18-127
Eye Dressing Forceps, 4" Serr,
Straight Tips, Non-magnetic



G18-130
Eye Dressing Forceps, 4" Half-
Curved Tips, Heavy Pattern

G18-129
Eye Dressing Forceps, Half
Curved, Serrated Tips, 4"



G18-131
Eye Dressing Forceps, Full
Curved, Serrated Tips, 4"



G20-25
Ferris Smith Tissue Forceps,
2x3 Teeth, 6 3/4"



G18-144
Iris Tissue Forceps 4" 1x2th
Straight, Standard

G18-146
Iris Tissue Forceps 4" 1/2 Half-
Curved

G18-147
Iris Tissue Forceps 4", 1x2th,
Full Curved



G13-613
Lahey Vulsellum Forceps,
3X3 Teeth, 6 1/4"



G11-80
Pedifine Allis Tissue Forceps,
4X5 Teeth, 4 3/4"

G11-81
Pedifine Allis Tissue Forceps,
4X5 Teeth, 5 3/4"



G12-60
Plain (Splinter) Forceps, 3 1/2"

G12-61
Plain (Splinter) Forceps, 4 1/2"

Dressing & Tissue Forceps



G12-76
Potts-Smith Dressing Forceps,
Serrated Jaw, 6"

G12-48
Potts-Smith Dressing Forceps,
Serrated Jaw, 7"

G12-49
Potts-Smith Dressing Forceps,
Serrated Jaw, 8 1/4"

G12-84
Potts-Smith Dressing Forceps,
Serrated Jaw, 9 1/2"



G12-320
Semken Tissue Forceps, 1X2
Teeth, Curved Tips, Size 5"

G12-325
Semken Tissue Forceps, 2X3
Teeth, Curved Tips, Size 5"



G12-77
Potts-Smith Tissue Forceps,
1X2 Teeth, 6"

G12-51
Potts-Smith Tissue Forceps,
1X2 Teeth, 7"

G12-52
Potts-Smith Tissue Forceps,
1X2 Teeth, 8 1/4"

G12-71
Potts-Smith Tissue Forceps,
1X2 Teeth, 9 1/2"



G18-163
Von Graefe Fixation Forceps, Spring
Catch, Non-magnetic, 4 3/8"

Dressing & Tissue Forceps



G12-27
Thumb Dressing Forceps,
Serrated Jaws, 4 1/2"

G12-03
Thumb Dressing Forceps,
Serrated Jaws, 8"

G12-28
Thumb Dressing Forceps,
Serrated Jaws, 5"

G12-04
Thumb Dressing Forceps 10"
Serrated

G12-01
Thumb Dressing Forceps,
Serrated Jaws, 5 1/2"

G12-05
Thumb Dressing Forceps 12"
Serrated

G12-02
Thumb Dressing Forceps 6"
Serrated



G12-29
Thumb Tissue Forceps, 1x2 Teeth,
4 1/2"

G12-08
Thumb Tissue Forceps, 1x2
Teeth, 8"

G12-30
Thumb Tissue Forceps, 1x2
Teeth, 5"

G12-66
Thumb Tissue Forceps, 1x2
Teeth, 10"

G12-06
Thumb Tissue Forceps, 1x2
Teeth, 5 1/2"

G12-10
Thumb Tissue Forceps, 1x2
Teeth, 12"

G12-07
Thumb Tissue Forceps, 1x2
Teeth, 6"

Dressing & Tissue Forceps



G12-96
Thumb Tissue Forceps, 2x3 Teeth, 5"

G12-11
Thumb Tissue Forceps, 2x3 Teeth 5 1/2"

G12-12
Thumb Tissue Forceps, 2x3 Teeth,
6"

G12-13
Thumb Tissue Forceps, 2x3 Teeth,
8"

G12-97
Thumb Tissue Forceps, 3x4 Teeth,
5"

G12-16
Thumb Tissue Forceps, 3x4 Teeth,
5 1/2"

G12-17
Thumb Tissue Forceps, 3x4 Teeth,
6"

Ear Instruments



G19-179
Bane Mastoid Rongeur, Curved,
7"



G19-181
Beyer-Stille Rongeur 7" 4x15mm
Bite Curved

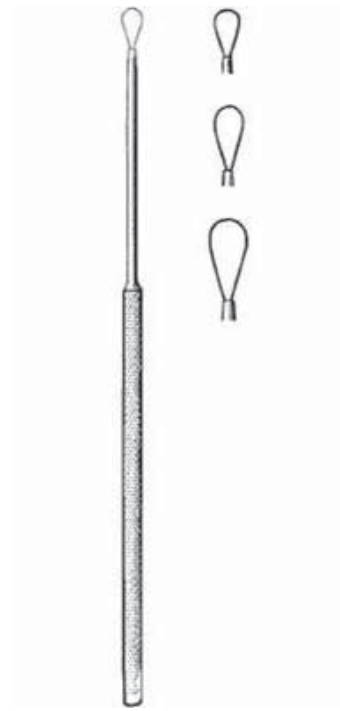

G19-19
Billeau Ear Loops, Delicate, 6 1/2",
small Loop

G19-18
Billeau Ear Loops, Delicate, 6 1/2",
medium Loop

G19-17
Billeau Ear Loops, Delicate, 6 1/2",
Large Loop

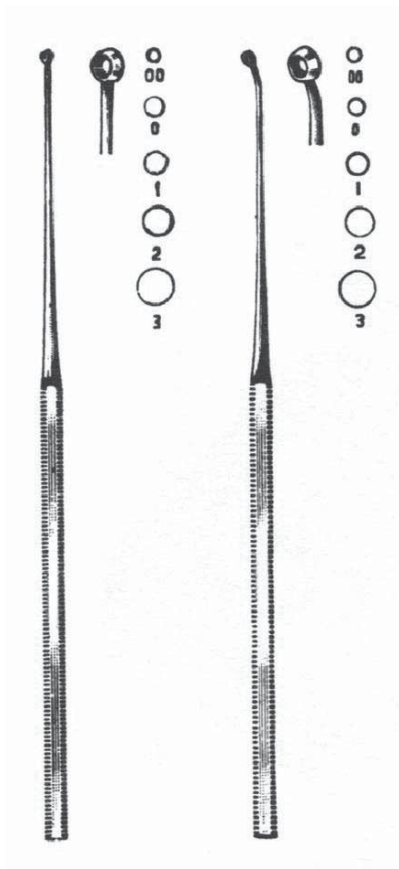

G19-26
Buck Ear Curette, 5 1/2",
Straight, Sharp, Size 5

G19-27
Buck Ear Curette, 5 3/4",
Angled Sharp, Size 00

G19-28
Buck Ear Curette, 5 3/4",
Angled Sharp, Size 0

G19-29
Buck Ear Curette, 5 3/4",
Angled Sharp, Size 1

G19-30
Buck Ear Curette, 5 3/4",
Angled Sharp, Size 2

G19-31
Buck Ear Curette, 5 3/4",
Angled Sharp, Size 3

G19-32
Buck Ear Curette, 5 3/4",
Angled Sharp, Size 4

G19-33
Buck Ear Curette, 5 3/4",
Angled Sharp, Size 5

G19-34
Buck Ear Curette, 5 3/4",
Straight Blunt, Size 00

G19-35
Buck Ear Curette, 5 3/4",
Straight Blunt, Size 0

G19-36
Buck Ear Curette, 5 3/4",
Straight Blunt, Size 1

G19-37
Buck Ear Curette, 5 3/4",
Straight Blunt, Size 2

G19-38
Buck Ear Curette, 5 3/4",
Straight Blunt, Size 3

G19-39
Buck Ear Curette, 5 3/4",
Straight Blunt, Size 4

G19-40
Buck Ear Curette, 5 3/4",
Straight Blunt, Size 5

G19-41
Buck Ear Curette, 5 3/4",
Angled Blunt, Size 00

G19-42
Buck Ear Curette, 5 3/4",
Angled Blunt, Size 0

G19-43
Buck Ear Curette, 5 3/4",
Angled Blunt, Size 1

G19-44
Buck Ear Curette, 5 3/4",
Angled Blunt, Size 2

G19-45
Buck Ear Curettes, 5 3/4",
Angled blunt, size 3

G19-46
Buck Ear Curette, 5 3/4",
Angled Blunt, Size 4

G19-47
Buck Ear Curette, 5 3/4",
Angled Blunt, Size 5

G19-20
Buck Ear Curette, 5 1/2",
Straight, Sharp, Size 00

G19-21
Buck Ear Curette, 5 1/2",
Straight, Sharp, Size 0

G19-22
Buck Ear Curette, 5 1/2",
Straight, Sharp, Size 1

G19-23
Buck Ear Curette, 5 1/2",
Straight, Sharp, Size 2

G19-24
Buck Ear Curette, 5 1/2",
Straight, Sharp, Size 3

G19-25
Buck Ear Curette, 5 1/2",
Straight, Sharp, Size 4

Ear Instruments



G21-96
Poole Suction Tube 23
Fr. Curved

G21-95
Poole Suction Tube 30
Fr. Straight



G21-138
Pynchon Suction Tube 10" tip
with large removable tubing

G21-136
Pynchon Suction Tube 11" tip
with large removable tubing



G21-10
Yankauer Suction Tube 11 3/4"
with removable tip and tubing
connection



G21-11
Yankauer Suction Tube,
chrome plated, replacement
tip only



G19-107
Baron Suction Tube, Size 3
French, 7 1/2"

G19-108
Baron Suction Tube, Size 5

G19-109
Baron Suction Tube, Size 7
French, 7 1/2"



G19-59
Ferguson-Frazier Suction Tubes,
10 French

G19-61
Ferguson-Frazier Suction Tubes,
14 French

G19-62
Ferguson-Frazier Suction Tubes,
12 French

G19-63
Ferguson-Frazier Suction Tubes,
6 French

G19-64
Ferguson-Frazier Suction Tubes,
7 French

G19-65
Ferguson-Frazier Suction Tubes,
8 French

G19-66
Ferguson-Frazier Suction Tubes,
11 French

G19-85
Ferguson-Frazier Suction Tubes,
9 French



G104-01
Hartman Alligator Forceps
Serrated Jaw, 3"

G104-02
Hartman Alligator Forceps
Serrated Jaw, 5 1/2"

G104-03
Hartman Alligator Forceps
Serrated Jaw, 6 1/2"

G104-04
Hartman Alligator Forceps
Round Cup Jaws, 2 1/2"

G104-05
Hartman Alligator Forceps
1 x 2 Teeth



G24-360
Hartman Rongeur, Curved,
4x12mm bite, Size 5 3/4"



G22-245
Volkman Double Ended
Curette, 5" 6 x10mm



G09-02
Taylor Percussion Hammer 7"

G09-01
Taylor Percussion Hammer 8"



G19-161
Volkman Bone Curette Size 0

G19-162
Volkman Bone Curette Size 1

G19-160
Volkman Bone Curette Size 2/0

G19-163
Volkman Bone Curette Size 2

G19-159
Volkman Bone Curette Size 3/0

G19-164
Volkman Bone Curette Size 3

G19-158
Volkman Bone Curette Size 4/0

G19-165
Volkman Bone Curette Size 4

G19-157
Volkman Bone Curette Size 5/0

G19-166
Volkman Bone Curette Size 5

G19-167
Volkman Bone Curette Size 6

Forceps



G11-19
Babcock Abdominal Forceps, 6 1/4"
G11-60
Babcock Abdominal Forceps, 8"
G11-45
Babcock Abdominal Forceps, 9 1/2"



G12-44
Carmalt (Splinter) Forceps,
Straight, 4 3/4"
G12-45
Carmalt (Splinter) Forceps,
Curved, 4 3/4"



G40-06
Castroviejo Suturing Forceps, Curved,
0.5mm Tip with tying platform, 4 1/4"
G18-187
Castroviejo Suturing Forceps,
Straight, 0.5mm Tip with tying plat-
form, 4 1/4"



G11-168
Baby Doyen Intestinal Forceps
Straight 6 1/2"
G11-169
Baby Doyen Intestinal Forceps
Curved 6 1/2"



G11-174
Doyen Intestinal Forceps Straight 9"
G11-175
Doyen Intestinal Forceps Curved 9"

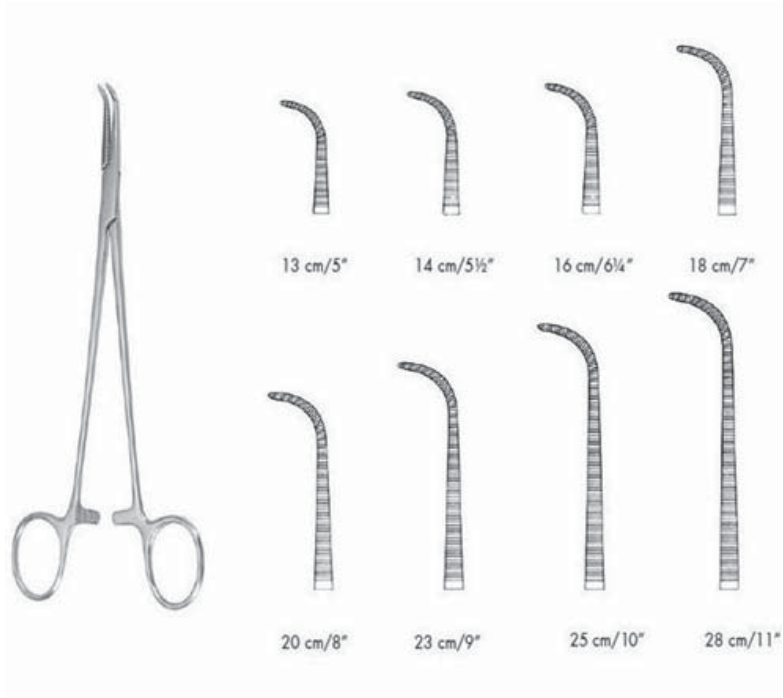

G11-114
Gemini-Mixer, Delicate,
Full Curved Jaws, 5 1/2"

G11-115
Gemini-Mixer, Delicate,
Full Curved Jaws, 7"

G11-116
Gemini-Mixer, Delicate,
Full Curved Jaws, 8"

G11-117
Gemini-Mixer, Delicate,
Full Curved Jaws, 9"

Grooming Instruments



G22-295
Tissue & Cuticle Nipper 4",
Convex Jaws

G22-296
Tissue and Cuticle Nipper,
Convex Jaws, 4 1/2"



G22-297
Tissue & Cuticle Nipper 4",
Convex Jaws



G1009-01
White Toe Nail Scissors 4 1/2"

Hemostatic Forceps



G11-05
Crile Hemostatic Forceps
Straight 5 1/2"

G11-06
Crile Hemostatic Forceps
Curved 5 1/2"



G11-90
Crile-Rankin Hemostatic Forceps,
Straight, 6 1/4"

G11-91
Crile-Rankin Hemostatic Forceps,
Curved, 6 1/4"



G22-79
Hartman Mosquito Forceps,
Curved Standard Pattern, 3 1/2"

G22-78
Hartman Mosquito Forceps,
Straight Standard Pattern, 3 1/2"

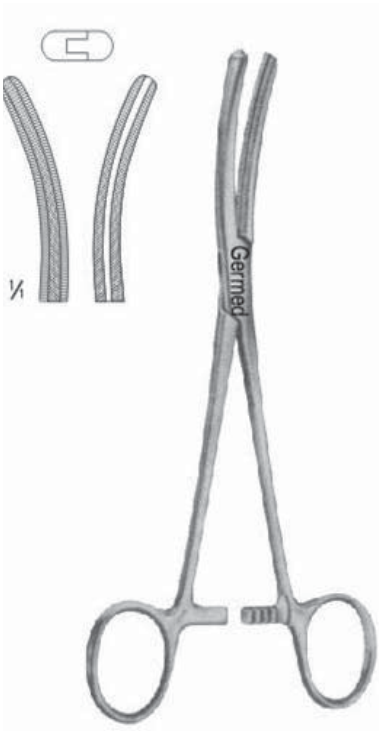

G11-119
Ferguson Angiotribe Forceps
Straight 6 1/2"

G11-120
Ferguson Angiotribe Forceps
Curved 6 1/2"

G11-121
Ferguson Angiotribe Forceps
Straight 7 1/2"

G11-122
Ferguson Angiotribe Forceps
Curved 7 1/2"



G11-302
Jacobson Micro Mosquito Forceps, Straight,
extremely delicate, Size 5"

G11-304
Jacobson Micro Mosquito Forceps, Curved,
extremely delicate, Size 5"

G11-306
Jacobson Micro Mosquito Forceps, Curved,
extremely delicate, Size 7"

G11-307
Jacobson Micro Mosquito Forceps, Straight,
extremely delicate, Size 7"



G22-76
Halstead Mosquito Forceps,
Straight 1x2 Teeth, 5"
G22-77
Halstead Mosquito Forceps,
Curved 1x2 Teeth, 5"



G11-300
Halstead Mosquito Forceps,
extra delicate, Straight, Size 5".
G11-301
Halstead Mosquito Forceps,
extra delicate, Curved, Size 5".



G11-01
Halstead Mosquito Forceps
Straight 5"
G11-02
Halstead Mosquito Forceps
Curved 5"



G11-03
Kelly Hemostatic Forceps
Straight 5 1/2"
G11-04
Kelly Hemostatic Forceps
Curved 5 1/2"



G11-104
Peers Towel Clamp,
Non-Perforating, 5 1/2"

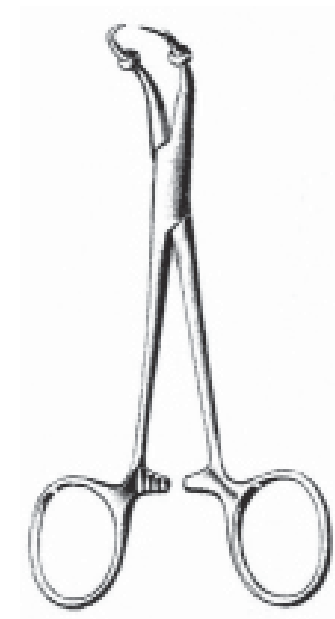

G11-28
Roeder Towel Clamp 5 1/4"

Hemostatic Forceps



G11-66
Providence Hospital Hemostatic
Forceps Straight 5 1/2"

G11-67
Providence Hospital Hemostatic
Forceps Curved 5 1/2"



G11-68
Rankin-Kelly Forceps Straight
6 1/4"

G11-69
Rankin-Kelly Forceps Curved
6 1/4"



G11-49
Rochester-Carmalt Forceps
6 1/4" Straight

G11-50
Rochester-Carmalt Forceps
6 1/4" Curved

G11-47
Rochester-Carmalt Forceps
8" Straight

G11-48
Rochester-Carmalt Forceps
8" Curved



G11-35
Rochester-Ochsner (Kocher) For-
ceps, Straight, 1x2 Teeth, 5 1/2"

G11-36
Rochester-Ochsner (Kocher) For-
ceps, Curved, 1x2 Teeth, 5 1/2"

Hemostatic Forceps



G11-43
Rochester-Ochsner (Kocher)
Forceps, Straight, 1x2 Teeth, 9"

G11-44
Rochester-Ochsner (Kocher)
Forceps, Curved, 1x2 Teeth, 9"

G11-105
Rochester-Ochsner (Kocher)
Forceps, Straight, 1x2 Teeth, 10"

G11-107
Rochester-Ochsner (Kocher)
Forceps, Curved, 1x2 Teeth, 10"



G11-160
Thoms-Allis Tissue Forceps,
6X7 Teeth, 8"



G11-07
Rochester-Pean Forceps,
Straight, 6 1/4"

G11-08
Rochester-Pean Forceps,
Curved, 6 1/4"

G11-31
Rochester-Pean Forceps,
Straight, 7 1/4"

G11-32
Rochester-Pean Forceps,
Curved, 7 1/4"

G11-33
Rochester-Pean Forceps,
Straight, 8"

G11-34
Rochester-Pean Forceps,
Curved, 8"

G11-51
Rochester-Pean Forceps,
Straight, 9"

G11-52
Rochester-Pean Forceps,
Curved, 9"

G11-99
Rochester-Pean Forceps,
Straight, 10"

G11-102
Rochester-Pean Forceps,
Curved, 10"

Hemostatic Forceps



G11-10
Rochester-Ochsner Forceps
Curved 6 1/4" 1x2th

G11-09
Rochester-Ochsner Forceps
Straight 7 1/4" 1x2th

G11-39
Rochester-Ochsner Forceps
Straight 7 1/4" 1x2th

G11-40
Rochester-Ochsner Forceps
Curved 7 1/4" 1x2th

G11-41
Rochester-Ochsner Forceps
Straight 8" 1x2th

G11-42
Rochester-Ochsner Forceps
Curved 8" 1x2th

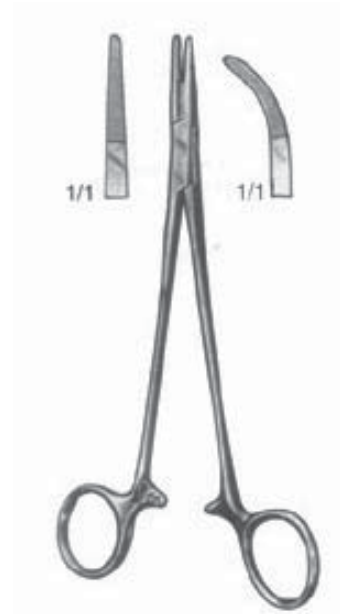

G11-54
Adson Forceps, Curved, 7 1/4"

G11-53
Adson Forceps, Straight, 7 1/4"

Knife Handles



G08-01
Knife Handle No. 3, Fits
blades 10-15



G08-06
Knife Handle No. 3,
Graduated in Millimeters



G08-02
Knife Handle No. 3L,
Long handle for Deep Surgery



G08-03
Knife Handle No. 4,
Fits Blades, 20- 25



G08-07
Knife Handle No. 4,
Graduated in Millimeters



G08-04
Knife Handle No. 4L, Fits Blades
2025, Long Handle for Deep



GD50-1206
Knife Handle No. 5, Fits Blades
10-15, Extra Fine, Plastic



GD50-1207
Knife Handle No. 6, Fits Blades
20-25, Extra Fine, Plastic



G08-05
Knife Handle No.7



G08-09
Knife Handle, Round,
Fitting blades 10-15



G08-12
Microsurgical (Beaver) Blade
Handle 4" in Length

G08-13
Microsurgical (Beaver) Blade
Handle 5" in Length

Measuring



G24-55
Depth Gauge, Regular

G24-56
Depth Gauge, Mini Screw



G18-292
For measuring and marking,
3 1/4", 8.5 cm



G29-13
Goniometer Polk Finger 6"
Graduated cm/inch

Miscellaneous Instruments

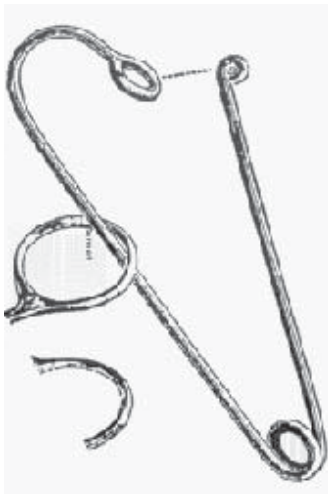

G09-60
Bunt Forceps Holder



G1110-01
Quick Lock Tourniquet with 32"
Neoprene cord
G1110-02
Neoprene Cord 32" For Tourni-
quet



GD50-557
Sterilizer, Needle, Spiral Rack



G09-05X
Finger Ring Cutter Blade Only

G09-05
Finger Ring Cutter With Blade

Nasal Instruments



G20-106
Gruenwald Nasal Punch 4 1/2" Shaft,
2 x 10mm Bite

G20-107
Gruenwald Nasal Punch 4 1/2" Shaft,
2.5 x 12mm Bite

G20-108
Gruenwald Nasal Punch, 4 1/2" Shaft,
3 X 12mm Bite



G20-109
Meltzer Adenoids Nasal Punch
5" Shaft, Large Round Jaws, Size

Nasal Instruments

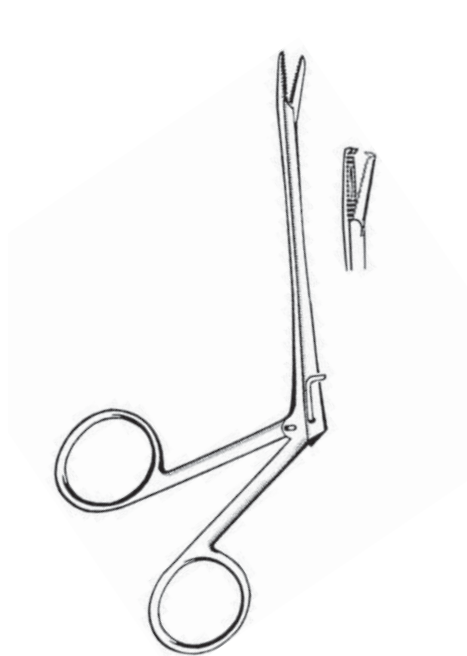

G19-144
Hartman-Noyes Ear Forceps,
Alligator Type, Serr, 3" Shaft



G20-69
Noyes Alligator Forceps,
Serrated Shaft, 5 1/2"
G20-70
Noyes Alligator Forceps, Ser-
rated Shaft, 6 1/2"

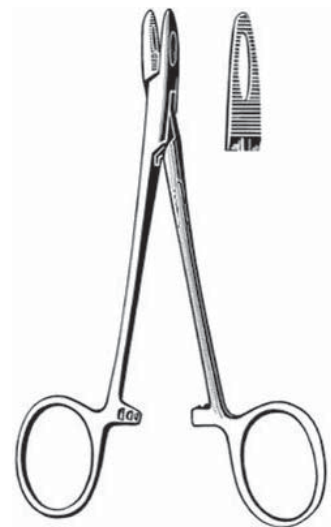

G14-16
Collier Needle Holder 5"

Needle Holder



G14-07
Webster Needle Holder,
Smooth Jaws, 5"



G18-46
Barraquer Needle Holder,
Straight, Smooth Jaws with Lock, 5
1/2"

G18-52
Barraquer Needle Holder,
Smooth Jaws 5 1/4"

G18-51
Barraquer Needle Holder,
Delicate Curved Jaw with lock 5
1/4"

Needle Holders



G18-55
Castroviejo Needle Holder, 5
1/2", Straight Jaw Without Catch

G18-56
Castroviejo Needle Holder,
Straight, Smooth with Lock 5 1/2"

G18-57
Castroviejo Needle Holder, 5 1/4",
Curved Jaw With Catch

G18-392
Castroviejo Needle Holders, With-
out Lock, Curved, 5 1/2"



G17-155
Castroviejo Needle Holder,
Straight, Smooth with Lock,
Tungsten Carbide, 5 1/2"



G17-46
Mayo Hegar Needle Holders,
Serrated, 7", Tungsten Carbide

G17-47
Mayo Hegar Needle Holders,
Serrated, 8", Tungsten Carbide

G17-48
Mayo Hegar Needle Holders,
Serrated, 9", Tungsten Carbide

G17-49
Mayo Hegar Needle Holders,
Serrated, 10 1/2", Tungsten Carbide

G17-131
Mayo Hegar Needle Holder,
Tungsten Carbide, 12"



G14-43
Mayo Hegar Needle Holder 5
1/4"

G14-03
Mayo Hegar Needle Holder 6"

G14-04
Mayo Hegar Needle Holder 7"

G14-05
Mayo Hegar Needle Holder 8"

G17-160
Mayo Hegar Needle Holder,
Serrated, 5 1/4", Tungsten Carbide

G17-45
Mayo Hegar Needle Holders,
Serrated, 6", Tungsten Carbide

Needle Holders



G14-18
Baby Olsen-Hegar Needle Holder,
4 1/2", Tungsten Carbide



G14-41
Olsen-Hegar Needle Holder,
European Pattern, 6 1/2"



G14-12
Olsen-Hegar Combined Needle
Holder & Scissors 5 1/2"

G14-13
Olsen-Hegar Combined Needle
Holder & Scissors 6 1/2"

G14-06
Olsen-Hegar Combined Needle
Holder & Scissors 7 1/4"



G17-128
Olsen-Hegar Combined Needle
Holder and Scissors, Delicate,
Serr, 4 3/4", Tungsten Carbide

G17-68
Olsen-Hegar Needle Holder,
Tungsten Carbide, 5 1/2"

G17-55
Olsen-Hegar Combined Needle
Holder and Scissors, 6 1/4", Serr,
Tungsten Carbide

G17-69
Olsen-Hegar Needle Holder,
Tungsten Carbide, 7 1/2"



G14-38
Micro Surgery Needle Holder, 7
1/8", Straight Jaws With Lock

G14-39
Micro Surgery Needle Holder, 7
1/8", Curved Jaws With Lock

G14-34
Micro Surgery Needle Holder 7 1/8",
Straight Jaws

G14-36
Micro Surgery Needle Holder 7 1/8",
Curved Jaws



G14-00
Halsey Needle Holder,
Serrated Jaws, 5"

G14-08
Halsey Needle Holder,
Smooth Jaws, 5"

G14-37
Micro Surgery Needle Holder, 5 1/4"
G14-35
Micro Surgery Needle Holder 5 1/4",
Curved Jaws



G17-66
Halsey Needle Holder,
Tungsten Carbide, Serrated Jaw, 5"

G17-67
Halsey Needle Holder,
Tungsten Carbide, Smooth Jaw, 5"



G14-10
Heaney Needle Holder Curved,
8 1/4"

G14-110
Heaney Needle Holder Curved,
10"



G17-165
Heaney Needle Holder,
Tungsten Carbide, Curved, 10"

Needle Holders



G14-90
Crile-Wood Needle Holder,
Tungsten Carbide, 7"

G14-91
Crile-Wood Needle Holder,
Tungsten Carbide, 8"

G14-92
Crile-Wood Needle Holder,
Tungsten Carbide, 9"

G17-133
Crile-Wood Needle Holder,
Tungsten Carbide, 10"

G17-134
Crile-Wood Needle Holder,
Tungsten Carbide, 12"



G14-02
Crile-Wood Needle
Holder, Standard 6"



G40-08
Cruciate Needle Holder,
Tungsten Carbide Jaws, 7"



G17-83
Derf Needle Holder, Serrated,
4 3/4", Tungsten Carbide

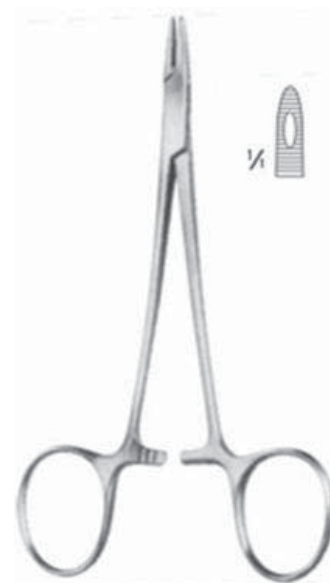

G14-15
Derf Needle Holder 4 3/4" Serrated



G17-135
Ryder (French Eye) Needle
Holder, Tungsten Carbide, 5"

G17-136
Ryder (French Eye) Needle
Holder, Tungsten Carbide, 6"

G17-137
Ryder (French Eye) Needle
Holder, Tungsten Carbide, 7"

G17-72
Ryder (French Eye) Needle
Holder, Tungsten Carbide, 8"

G17-138
Ryder (French Eye) Needle
Holder, Tungsten Carbide, 9"



G17-90
Mathieu Needle Holder,
Tungsten Carbide, 5 1/2"

G17-91
Mathieu Needle Holder,
Tungsten Carbide, 6 1/2"



G17-164
Baumgartner Needle Holders,
Serrated, 5", Tungsten Carbide

G17-44
Baumgartner Needle Holders,
Serrated, 5 1/2", Tungsten Carbide



G14-93
Baumgartner Needle Holder
5 1/2"



G46-132
Adson Cranial Rongeur,
Straight jaws 7 x 13 mm, Size 8"

G46-134
Adson Cranial Rongeur,
Curved jaws 7 x 13 mm, Size 8"

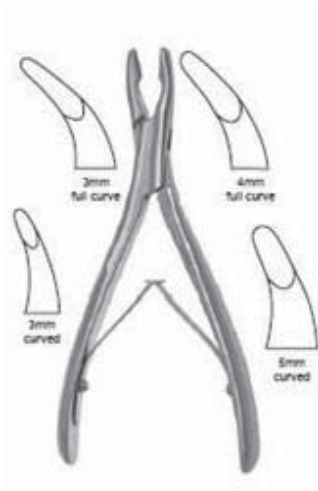

G24-752
Luer Rongeur 8x10mm Bite
Straight 7"

G24-754
Luer Rongeur 8x10mm Bite
Curved 7"



G19-71
Luer Rongeurs, Straight, 7"

G19-72
Luer Rongeurs, Curved, 7"



G24-30
Stille-Luer Rongeur, Curved 8 3/4"

G24-31
Stille-Luer Rongeur 8 1/2"
9x15mm Bite Curved

G24-31S
Stille-Luer Rongeur 8 1/2" 9x15mm
Bite Straight

G24-32
Stille-Luer Rongeur, Curved
Angled 9"



G46-142
Fulton Laminectomy Rongeur,
Straight jaws, 7 x 18 mm, Size 9 1/2"

G46-144
Fulton Laminectomy Rongeur, slightly
curved jaws, 7 x 18 mm, Size 9 1/2"



G46-114
Bailey Saw Guide 12"



G46-116
Michele Trepine, 6 1/4" shaft

G46-118
Michele Trepine, 6 1/4" graduated

G46-122
Michele Trepine, Marker



G46-100
Gigli Saw Handle, T-Shape turn-
able, Standard 2 1/2"

G46-102
Gigli-Strully Saw Handle, T-Shape,
Rigid with snap lock, Standard.

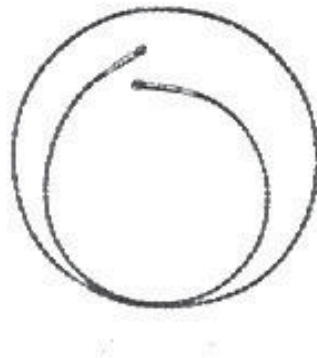

G46-108
Gigli Saw 12", Standard twisted wire
type.

G46-110
Gigli Saw 20", Standard twisted wire
type.

G46-112
Gigli Saw 30", Standard twisted wire
type.



G46-104
Modified Gigli Bone Saw Wire,
Turnable
G46-106
Modified Gigli Bone Saw Wire,
Loop Grip



G40-01
Barraquer Eye Speculum (Colibri)
1 1/4"
G40-02
Barraquer Eye Speculum (Colibri)
1 1/2"
G18-44
Barraquer Eye Speculum Large
Blades 1 3/4"



G40-04
Castroviejo Eye Speculum 3 3/4"



G18-45
Lancaster Eye Speculum 2 3/4"



G40-03
Graefe Eye Speculum 3 1/2"



G18-186
Plain Wire Speculum,
15mm Wide Blades 2 1/2"



G40-07
Desmarres Chalazion Forceps,
16mm, 3 1/2"

G18-216
Desmarres Chalazion Forceps,
20mm Diameter, 3 1/2"

G18-217
Desmarres Chalazion Forceps,
25mm Diameter, 3 1/2"

G18-218
Desmarres Chalazion Forceps,
30mm Diameter, 3 1/2"



G18-291
Eye Suture Scissors, Curved
Pointed Blades 3 3/4"



G18-194
Jeweler's Forceps # 7 Swiss Style,
Extra Fine Tips, Curved, 4 1/2"



G40-05
Jeweler's Forceps, # 5 Swiss Style,
Fine Points, Angled, 4 1/2"

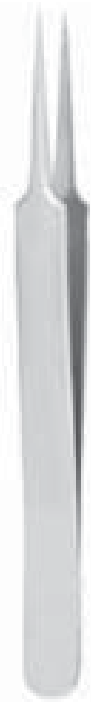

G18-193
Jeweler's Tweezers, #5
Superfine Point, 4 3/4"



G18-159
Graefe Fixation Forceps 4 3/8",
Without Catch

G18-160
Graefe Fixation Forceps 4 3/8"
Non magnetic without catch



G19-101
Jansen Bayonet Forceps,
Serrated, 7 1/2"

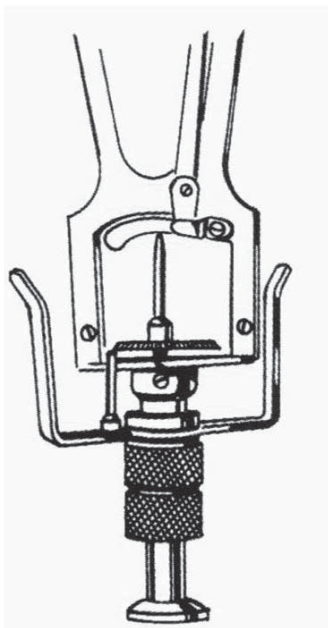

G18-304-1
Schiotz Tonometer

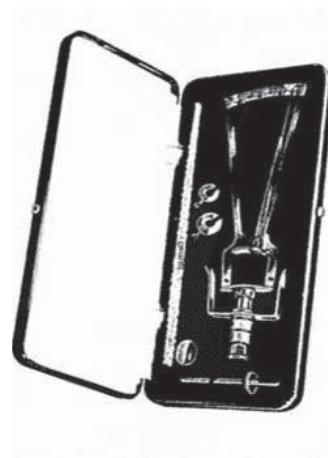

G18-304
Schiotz Tonometer, Complete
With Case



G18-304-3
Sterilizing Case for schiotz tonometers 6 1/2". 3 1/2". 1 1/4" fitted to firmly hold tonometer, weights and test block



G10-SC-48
Stevens Tenotomy 4 1/2" Straight, Supercut

G10-SC-49
Stevens Tenotomy 4 1/2" Curved, Supercut



G17-1201
Stevens Tenotomy Straight 4 1/2"

G17-1202
Stevens Tenotomy Curved 4 1/2"



G18-268
Stevens Tenotomy Scissors 4 1/2", Slender Style, Straight, With

G18-269
Stevens Tenotomy Scissors 4 1/2", Slender Style, Slightly Curved, With Blunt

G10-48
Stevens Tenotomy Scissors, Straight 4 1/4" Blunt Tips

G10-49
Stevens Tenotomy Scissors, Curved 4 1/4" Blunt Tips

Ophthalmic Instruments



G18-239
Strabismus Scissors, Straight,
4 1/4" / 11.5 cm
G18-240
Strabismus Scissors, curved,
4 1/4" / 11.5 cm



G18-349
Troutman-Barraquer Colibri Type
Corneal Utility Forceps, 3", 0.4mm
G18-350
Troutman-Barraquer Colibri Type
Corneal Utility Forceps, 3", 12mm

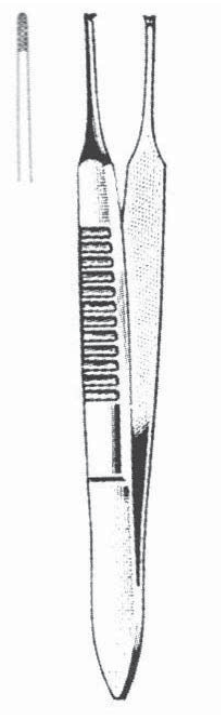

G18-156
Von Graefe Iris Forceps, 2 3/4"
Curved, Delicate, 1x2 Teeth
G18-157
Von Graefe Iris Forceps, serrated
tips, curved, delicate, 2 3/4"

Orthopedic Instruments



G24-60
Cruciate Repair Crimping Forceps



G46-318
Dandy Nerve Hook 9"



G14-118
Ferguson Gall Stone Scoop Double
Ended, Small, 9 1/2"
G14-119
Ferguson Gall Stone Scoop Double
Ended, Medium, 9 1/2"
G14-120
Ferguson Gall Stone Scoop Double
Ended, Large, 9 1/2"



G21-147
Freer Elevators, Double Ended
With Blunt/sharp Blades, 7", 5mm



G13-241
Mini-Hohman Retractor 6 1/4" 6mm

G13-242
Mini-Hohman Retractor 6 1/4" 8mm



G13-936
Hohmann Retractor, 12 mm
Width, 8"

G13-244
Hohmann Retractor, 18mm Width,
8"

G13-246
Hohmann Retractor, 43mm Width
8"

G13-660
Hohmann Retractor, 18 mm Width,
9"

G13-245
Hohmann Retractor, 22mm Width,
9"

G13-247
Hohmann Retractor, 70mm Width
9"

G13-243
Hohmann Retractor 10mm wide,
9 1/4"



G22-249
Meniscus Knife 7 1/2"



G24-112
Cannulated Pin and Wire Cutter
7 1/2"

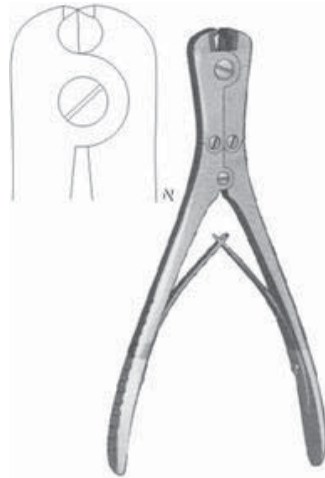

G24-118TC
C-n-S- front side Pin and Wire
Cutter

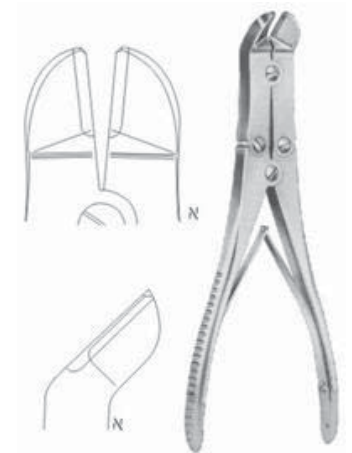

G17-158
C-N-S- Pin and Wire Cutter TC
Insert



G24-114
Diamond Pin and Wire cutter
6 1/2"



G24-116TC
Double Action Pin Cutter 15"



G24-37
Pin Cutter 19"



G24-108
Wire Twister, Tungsten Carbide
Insert Jaws, Size 6"
G24-110
Wire Twister, Tungsten Carbide
Insert Jaws, Size 8"



G19-206
Echlin Rongeur (Duckbill) 9" Angular
2x15mm Bite
G19-207
Echlin Rongeur (Duckbill) 9" Angular
3x15mm Bite
G19-208
Echlin Rongeur (Duckbill) 9" Angular
4x15mm Bite



G80-01
Duckbilled Mini-Ronguer 5"

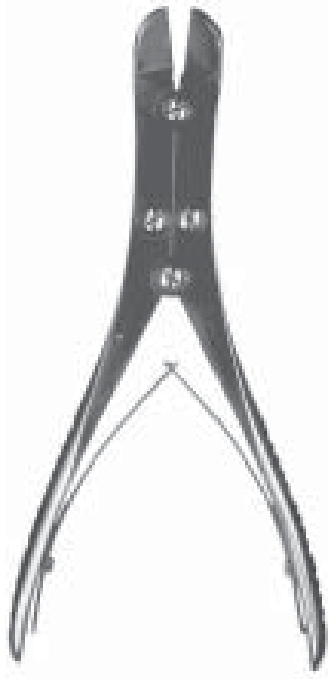

G17-81-01
K-wire sutter, TC 2.2MM
G17-81-02
K-wire sutter, TC 2.5MM



G24-52-08
Ligament Meniscus Clamp



G24-75
Graft Curved Passer, 2.0cm

G24-76
Graft Curved Passer, 3cm

G24-77
Graft Curved Passer, 4.5cm

G24-78
Graft Curved Passer, Extra Large

G24-79
Graft Curved Passer, xx-Large



G22-120
U.S. Army Pattern Osteo-
tomes,

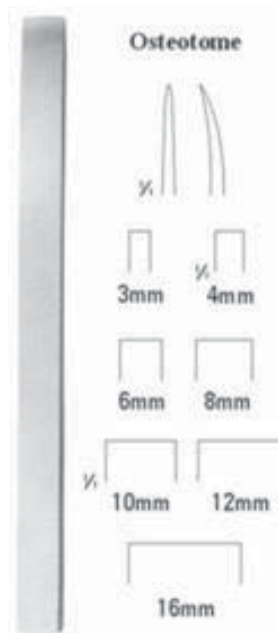

G24-222
Mini Lambotte Osteotome 5"
Straight 2mm

G24-224
Mini Lambotte Osteotome 5"
Straight 4mm

G24-226
Mini Lambotte Osteotome 5"
Straight 6mm

G24-227
Mini Lambotte Osteotome 5"
Straight 10mm

G24-228
Mini Lambotte Osteotome 5"
Straight 8mm

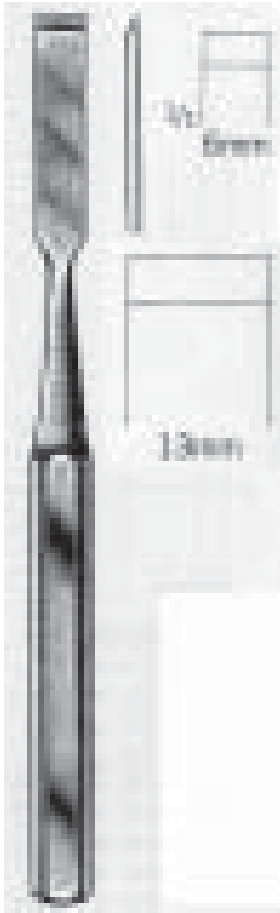

G22-125
Hoke Osteotomes, 5 1/2",
Straight, 1/8"

G22-126
Hoke Osteotomes, 5 1/2",
Straight, 3/16"

G22-127
Hoke Osteotomes, 5 1/2",
Straight, 1/4"

G22-128
Hoke Osteotomes, 5 1/2",
Straight, 5/16"

G22-129
Hoke Osteotomes, 5 1/2",
Straight, 3/8"

G22-130
Hoke Osteotomes, 5 1/2",
Straight, 1/2"



G24-51-06
K-wire Small Pin Punch



G22-90
Keyes Cutaneous Punch,
2 mm Tip, 4" (10cm)

G22-91
Keyes Cutaneous Punch,
3 mm Tip, 4" (10cm)

G22-92
Keyes Cutaneous Punch,
4 mm Tip, 4" (10cm)

G22-94
Keyes Cutaneous Punch,
6 mm Tip, 4" (10cm)

G22-96
Keyes Cutaneous Punch,
8 mm Tip, 4" (10cm)

Orthopedic Instruments



G12-31
Russian Forceps, 6"
G12-32
Russian Forceps, 8"
G12-33
Russian Forceps, 10"



G19-10
Lucae Forceps, Serrated, 5
1/2"



G45-354
Lovelace Lung Grasping Forceps, Angled
shanks serrated jaws 1" wide, 7 1/4"

G45-352
Lovelace Lung Grasping Forceps, Straight
serrated jaws 1" wide, 8"



G10-95A
Economy Utility Scissors,
Serrated, 5 1/2"
G10-95
Economy Utility Scissors,
Serrated, 7 1/2"



G24-59
Screwdriver 20mm



G24-65
Small Pin Hand, Chuck Vise



G24-285
Mallet Solid Stainless 11" 16oz



G24-275
Mead Mallet 7 1/2"



G24-260
Mallet, lightweight, 7.5 oz, Stainless head, Size 7 1/2"

G24-265
Mallet, lightweight, 9 oz, Stainless head, Size 7 1/2"



G20-57
Gerzog Mallet, 7 1/2" 7oz

G20-57A
Gerzog Mallet 7" 16oz

G20-57B
Gerzog Mallet 7 1/2" 10oz



G20-62
Lucae Mallet 7 3/4"
7oz Convex/Flat Head



G20-622
Lucae Mallet 8" 8oz Convex/
Flat



G24-39
Plate Bender Pliers



G24-38
Parallel Action Wire Cutters

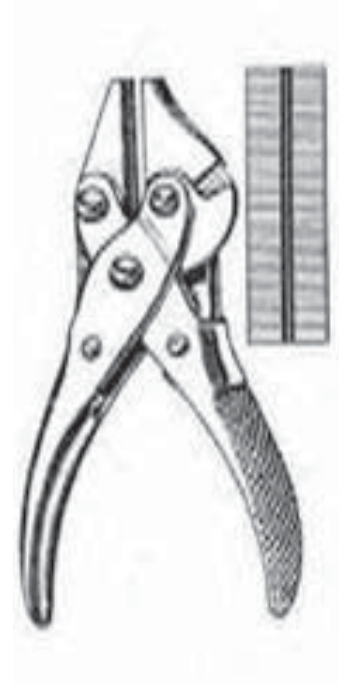

G24-106
Parallel Action Wire Cutters 4 1/2"

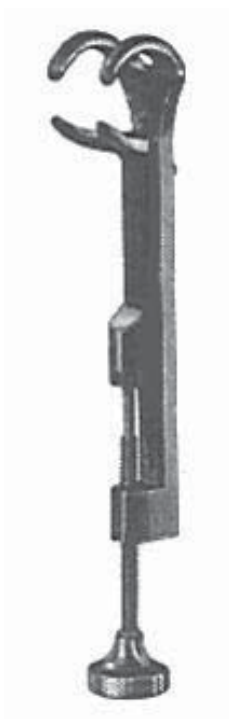

G24-100
Lambert-Lowman Bone Clamp,
Bone Clamp 1" Wide



G24-20
Liston Bone Cutting Forceps,
Angled, 5 1/2"

G24-16
Liston Bone Cutting Forceps,
Straight, 5 1/2"

G24-17
Liston Bone Cutting Forceps,
Straight, 7 1/2"

G24-21
Liston Bone Cutting Forceps,
Angled, 7 1/2"

G24-52
Liston Bone Cutting Forceps,
Angled, 8 3/4"

G24-51
Liston Bone Cutting Forceps,
Straight, 8 3/4"

Orthopedic Instruments



G19-18-01
Ruskin Bone Cutting Forceps
Straight 6"

G19-18-02
Ruskin Bone Cutting Forceps
Curved 6"

G19-80
Ruskin Bone Cutting Forceps
Straight Jaw 7 1/4"

G19-80A
Ruskin-Liston Cutting Forceps
Straight, 7 1/2"

G19-81
Ruskin Bone Cutting Forceps
Angled Jaw 7 1/4"

G19-81A
Ruskin-Liston Cutting Forceps,
Angled, 7 1/2"



G19-227
Lane Bone Forceps 13"
Standard Without Ratchet

G19-228
Lane Bone Forceps 13"
Standard With Ratchet

G19-229
Lane Bone Holding For-
ceps, 17" Standard Without
Ratchet

G19-230
Lane Bone Holding Forcps, 17"
With Ratchet



G19-219
Kern Bone Holding Forceps 9
1/2" Without Ratchet

G19-220
Kern Bone Holding Forceps 9
1/2" With Ratchet



G24-06
Lewin Bone Holding Forceps 7"



G24-42
Verbrugge Bone Holding For-
ceps, Small

G24-41
Verbrugge Bone Holding For-
ceps, Large



G24-43
Bone Bolding Forceps 5 1/2"



G45-430
Meeker Kantrowitz Forceps,
Full Curved Jaws, 7 3/4"



G24-501
Bone Fragment Forceps 4"
Regular

G24-500
Bone Fragment Forceps 6" Large



G24-40
Wire twister/Shear Cutter



G24-44
X-small serrated Bone Holding
Forceps



G11-88
Micro Mosquito Forceps, Straight,
Very Delicate Pattern, 4 3/4"

G11-89
Micro Mosquito Forceps, Curved,
Very Delicate Pattern, 4 3/4"



G22-24
Joseph Hook, Double Prong,
2mm Wide, 6"

G22-25
Joseph Hook Double Prong,
5mm Wide, 6"



G22-34
Joseph Hook, Sharp Single
Prong, 6"



G17-100
Gillies Hook, Small 8"



G501-02
Snook Hook, Blunt, 8" Solid Tip



G501-01
Snook Hook, Blunt, 8"



G22-248
Smillie Knife 6 3/4" Straight

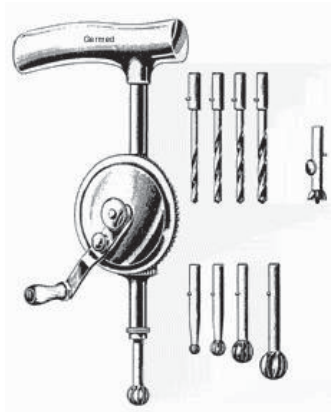

G29-01
Stille Pattern Drill Set



G15-810
Eppendorfer-Krause Rotating Shaft
Biopsy Forceps, Size 9", Shafts are
interchangeable



G24-152
Kirschner Wires/ w/flat end 0.9mm 12"

G24-154
Kirschner Wires/ w/flat end 1.1mm 12"

G24-156
Kirschner Wires, w/flat end 1.6mm 12"



G10-100
Engel Cast Cutter 6"



G16-162
Stille Pattern Vessel Clamp, 9"

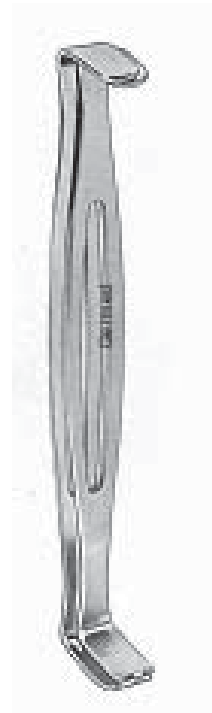

G13-24
U.S. Army Retractor, .625
Wide-Set of 2, 8.5"



GD50-701
Bone File, Double Ended, No.
10, 7"



GD50-705
Bone File, Double Ended, No.
12, 7"

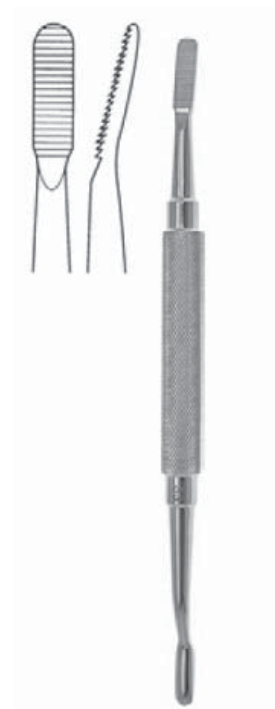

GD50-211
Bone File, Double Ended, No.
33, 7"

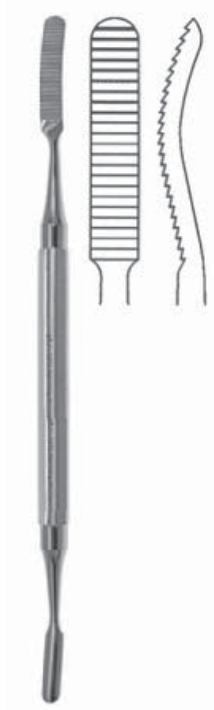

GD50-213
Bone File, Double Ended, No.
45, 7"

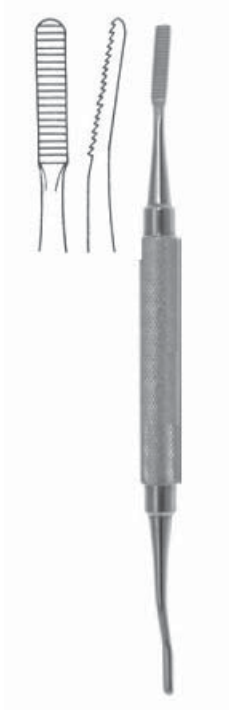

GD50-212
Bone File, Double Ended, No.
64, 7"



G22-239
Key Elevator, 7 1/2", Squared
.25"

G22-241
Key Elevator, 7 1/2", Squared .5"

G22-242
Key Elevator, 8", Squared .75"

G22-243
Key Elevator, 8 1/4", Squared
1.0"



G22-328-01
Excision Arthroplasty Rasp
170mm



G22-328-02
Trochlea Rasp 6 3/4"



G22-325
Fomon Rasp, Sided Teeth 8 1/4"

G22-326
Fomon Rasp, Coarse Teeth 8 1/4"

G22-328
Fomon Rasp, Fine Teeth 8 1/4"



G16-115
Mayo Common Duct Scoop Small,
Malleable, 10 1/2"

G16-116
Mayo Common Duct Scoop Medium,
Malleable, 10 1/2"

G16-117
Mayo Common Duct Scoop Large,
Malleable, 10 1/2"

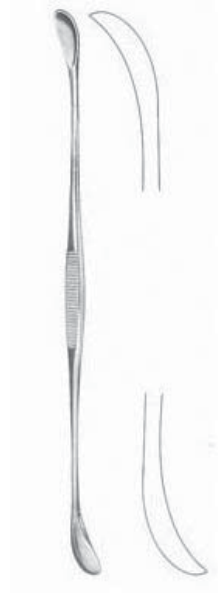

G16-114
Mayo Gall Stone Scoop,
Double Ended, 11"/28cm



V2001-06
Basic Periodontal Pack with
sharpening Stone & Oil

- 1 GD50-774 Tower-Jaquette Scaler
- 1 GD50-757 Columbia Curette
- 1 V25-G-206-01 Gracey Posterior Curette
- 1 V25-G-206-02 Gracey Anterior Curette
- 1 GD50-303-01 Probe/Explorer CP 12/23
- 1 GD50-1134-02 Sharpening Oil
- 1 G11-25-01 Arkanses Flat Stone



V2001-13
Basic Rabbit Dental Pack

- 1 Rongeur
- 1 Rabbit Mouth Gag
- 1 Rasp
- 1 Large Mouth Spatula
- 1 Small Mouth Spatula
- 1 Large Cheek Gag
- 1 Small Cheek Gag



**V2001-12
Advanced Rabbit Dental Pack**

- | | |
|-----------------------------------|--------------------------------|
| 1 G19-76 Lempert-Rongeur | 1 G21-20-02 Cheek Gag, Small |
| 1 V70-265 Rabbit Mouth Gag | 1 G21-20-03 Crossley Luxator#1 |
| 1 G22-15 Lewis rabbit Dental Rasp | 1 G21-20-04 Crossley Luxator#2 |
| 1 G46-25-01 Hollman Mouth Spatula | |
| 1 G46-25-02 Hollman Mouth Spatula | |
| 1 G21-20-01 Cheek Gag, Large | |



**V2001-03
Canine/Feline Spay Pack**

- | | |
|---|---|
| 1 G08-01 Knife Handle # 3 | 2 G11-02 Halsted Mosquito Forceps 5" Curved |
| 1 G10-28 Mayo Scissors 6 3/4" Straight | 2 G11-04 Kelly Forceps 5 1/2" Curved |
| 1 G10-39 Metzenbaum Scissors 7" Curved | 2 G11-50 Roch-Carmalt Forceps 6 1/4 Curved. |
| 1 G12-06 Tissue Forceps 5 1/2" 1 X 2 Teeth. | 4 G11-26 Backhaus Towel Clamp 3 1/2" |
| 1 G12-26 Brown Adson Forceps 4 3/4" 7 X 7
Teeth. | 1 G17-55 Olsen - Hegar Needle Holder* |
| | 1 G11-20 Allis Tissue Forceps 6" 4 x 5 Teeth. |
| | 1 G501-01 Snook Ovariectomy Hook |



**V2001-20
Cruciate Packs**

- | | | |
|--|---|---|
| 1 G08-01 #3 Knife Handle | 1 G11-02 Halstead Mosquito Forceps 5" Curved | 1 G21-131 Complete Dual Hand Chuck Pin Smooth 3/32" |
| 1 G10-27 Mayo Scissors 6 3/4" Straight | 1 G11-05 Crile Forceps 5 1/2" Straight | 1 G19-77 Lempert Rongeur 6 1/2" Curved |
| 1 Misc Roger Wire Cutting Scissors 4.75" | 1 G12-21 Adson Brown Forceps 4 3/4" | 1 G24-446 Universal Tensioning Device |
| 1 G19-59 Frazier Suction 10FR | 1 G14-13 Olsen Hegar Needle Holder 6 1/2" | 1 Misc Crimp Tubes |
| 1 G11-01 Halstead Mosquito Forceps 5" Straight | 1 G13-38 Senn Retractor 6 1/4" 3 Sharp Prongs | 1 G09-42 Cruciate Needles Set of 3 sizes |
| | 1 G13-958 Hohmann Retractor 6mm | 1 Misc Monofilament Nylon Suture Tray, Perforated |
| | 1 Misc Crimping Forceps | |

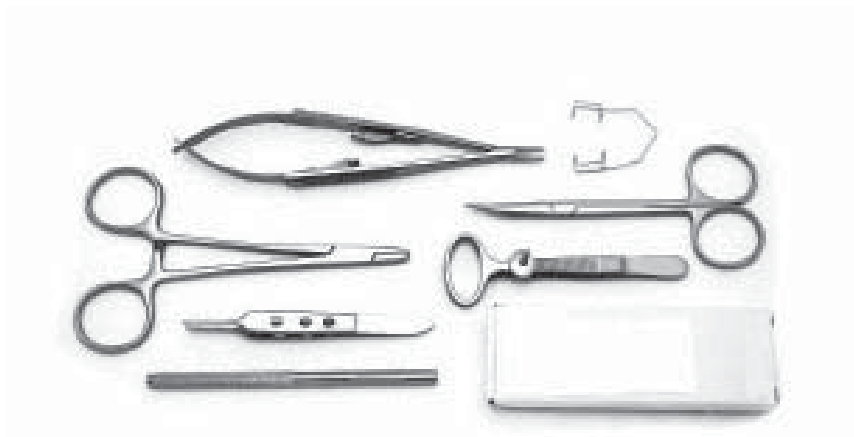

**GV100-04
German Advanced Eye Pack**

**GV100-05
Vet Advanced Eye Pack**

- | |
|---|
| 1 Micro Blade Handle |
| 1 Bishop- Harmon Forceps 4x2th 3 1/4" Delicate |
| 1 Desmarres Chalazion Forceps 3 1/2" 20mm Wide |
| 1 Stevens Tenotomy Scissors Curved |
| 1 Barraquer Wire Speculum 1 1/4" |
| 1 CastroViejo Needle holder with lock, Smooth Jaws 5 1/2" |
| 1 Microbeaver Blade Size 67 box of 12 |



GV100-01
German Starter Eye Pack

GV100-02
Vet Starter Eye Pack

- GV100-01**
 1 Derf Needle holder 4 3/4"
 1 Bishop- Harmon Forceps 4x2th 3 1/4" Delicate
 1 Stevens Tenotomy Scissors Curved 4 1/4"
 1 Barraquer Wire Speculum 1 1/4"

- GV100-02**
 1 Derf Needle holder 4 3/4"
 1 Bishop- Harmon Forceps 4x2th 3 1/2" Delicate
 1 Stevens Tenotomy Scissors Curved 4 1/2"
 1 Barraquer Wire Speculum 1 1/4"

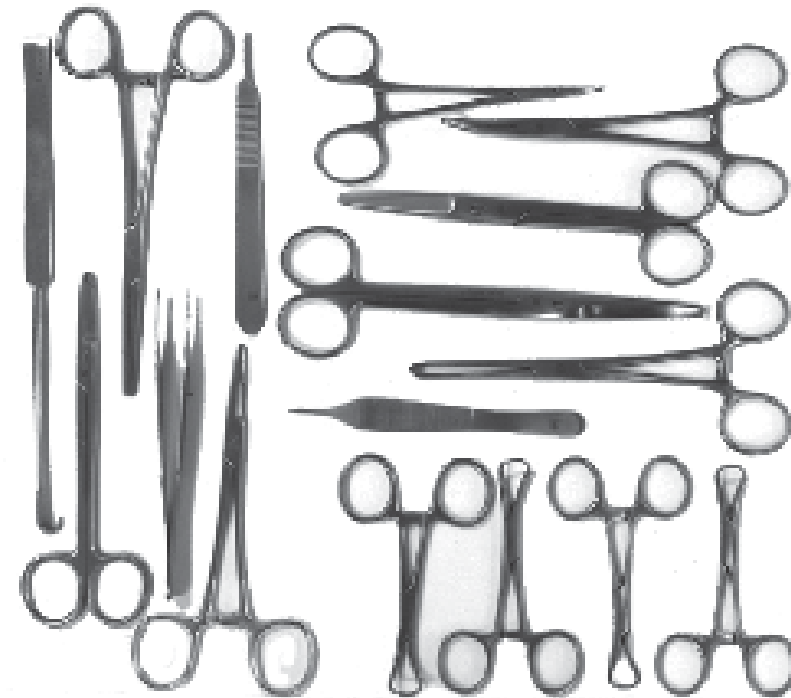

V2001-02
Spay Pack with Olsen Hegar N.H

- | | |
|-------------------------------------|--|
| 1 Operating Scissors S/B Straight | 4 Backhaus Towel Clamps 3 1/2" |
| 1 Adson Brown Tissue Forceps 4 3/4" | 1 Mayo Dissecting Forceps 6 3/4" Str. or Cvd. |
| 1 Adson Dressing Forceps 4 3/4" | 1 Kelly Forceps 5 1/2" Str or Cvd |
| 1 Allis Tissue Forceps 6" 4x5th | 1 Halstead Mosquito Forceps 5" Str or Cvd |
| 1 Littauer Stitch Scissors 5 1/2" | 1 Olsen Hegar Needle Holder 5 1/2" (or) 6 1/2" |
| 1 Surgical Handle #3 | |
| 1 Snook Hook | |



V2001-01
Spay Pack with Olsen Hegar
N.H.TC Insert

- | | |
|-------------------------------------|---|
| 1 Operating Scissors S/B Straight | 4 Backhaus Towel Clamps 3 1/2" |
| 1 Adson Brown Tissue Forceps 4 3/4" | 1 Mayo Dissecting Forceps 6 3/4" Str. or Cvd. |
| 1 Adson Dressing Forceps 4 3/4" | 1 Kelly Forceps 5 1/2" Str or Cvd |
| 1 Allis Tissue Forceps 6" 4x5th | 1 Halstead Mosquito Forceps 5" Str or Cvd |
| 1 Littauer Stitch Scissors 5 1/2" | 1 Olsen Hegar Needle Holder 5 1/2" or 6 1/2" |
| 1 Surgical Handle #3 | TC insert |
| 1 Snook Hook | |



V2001-07
Standard Veterinary Eye Pack

- | |
|---|
| 1 VG08-01 Scalpel Handle #3 |
| 1 VG18-44 Wire Eye Speculum |
| 1 VG18-126 Eye Dressing Forceps 4" |
| 1 VG10-216 Chalazion Forceps |
| 1 VG10-48 Stevens Tenotomy Scrs 4" Str. |
| 1 VG10-56 Castroviejo Needle Holder |



**GV100-06
Vet Advanced Eye Pack with Case**

- 1 CastroViejo Needle holder with lock, 1 Micro Blade Handle
- Smooth Jaws 5 1/2" 1 Bishop- Harmon Forceps 4x2th 3 1/4" Delicate
- 1 Microbeaver Blade Size 67 box of 12 1 Desmarres Chalazion Forceps 3 1/2" 20mm Wide
- 1 Sterilization Case w/mat 1 Stevens Tenotomy Scissors Curved
- 1 Wire Eye Speculum 1 1/4"



**GV100-03
Vet Starter Eye Pack with Case**

- 1 Derf Needle holder 4 3/4"
- 1 Bishop- Harmon Forceps 4x2th 3 1/2" Delicate
- 1 Stevens Tenotomy Scissors Curved 4 1/2"
- 1 Barraquer Wire Speculum 1 1/4"
- 1 Sterilization Case w/mat



**V2001-08
Standard Veterinary Orthopedic
Pack**

- 2 Senn Retractors
- 1 5.5" Sharp Weitlaner Retractor
- 1 Pair-Gigli Wire Handles
- 1 12" Gigli Wire Saw
- 1 6" Kern Bone Holding Forcep
- 1 8" Kern Bone Holding Forcep
- 1 Mead Mallet
- 1 2mm Bone Curette
- 1 8mm 5" Osteotome
- 1 9.25" Pin Cutter
- 1 Dean Rongeur
- 1 20 Gauge Ortho Wire
- 1 8.5" Fomon Rasp & File
- 1 Freer Elevator

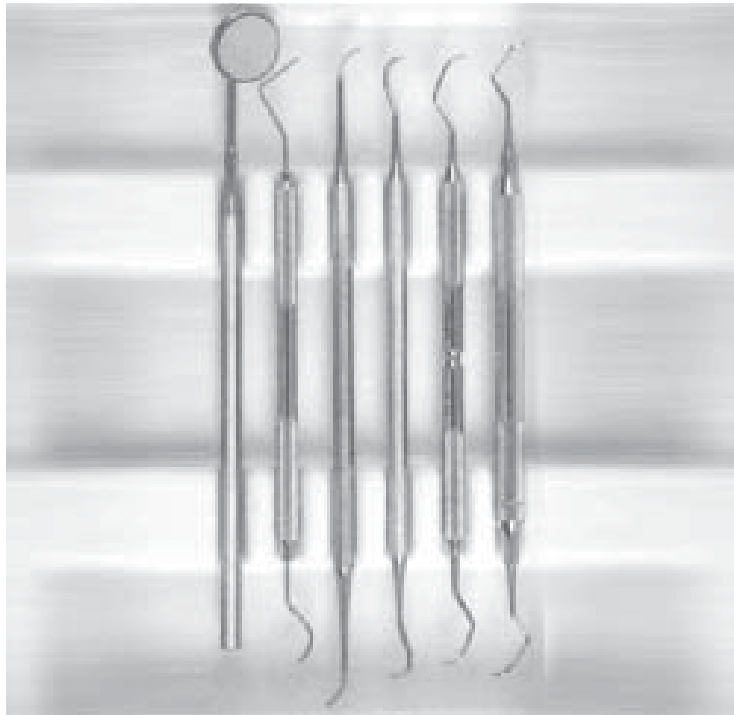

GD50-20-03
Veterinary Dental Set

- 1-Mirror #4
- 1-Explorer D/E/
- 1-Probe 20-23 Explorer
- 1-Curette Columbia 13-14 Fine
- 1-Curette Columbia 4L-4R
- 1-Scaler Jacquette 2S-3S
- 1-Universal Scaler/1-Sterilizing Tray

Directors & Probes



G14-115
Probe with Eye 4 1/2"

G16-14-5
Probe with Eye 5"

G14-116
Probe with Eye 5 1/2"

G16-14-6
Probe with Eye 6"

G16-14-8
Probe with Eye 8"

G16-14-10
Probe with Eye 10"

G14-117
Probe with Eye 12"



GD50-740
Probe/Explorer, Double Ended, 3,
6, 9, & 12mm markings



G14-111
Grooved Director 4 1/2"

G14-112
Grooved Director 5"

G14-113
Grooved Director 5 1/2"

G14-114
Grooved Director 6"

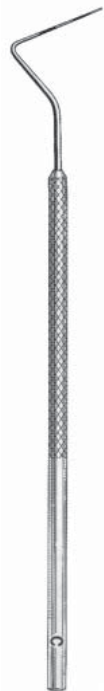

GD50-1537
Graduated Probe, Style "C"



G13-280
Baby Ribbon Retractor,
Malleable 1.0", 7"

G13-285
Baby Ribbon Retractor,
Malleable .25", 7"
G13-286
Baby Ribbon Retractor,
Malleable .5", 7"

G13-287
Baby Ribbon Retractor,
Malleable .75", 7"

Retractors



G13-205
Alm Retractor 2 3/4" 4x4
Prongs

G13-206
Alm Retractor 4" 4x4 Prongs

Retractors



G13-91
Baby Weitlaner Retractor 4" Sharp
2x3 Prongs

G13-92
Baby Weitlaner Retractor 4" Blunt
2x3 Prongs



G13-08
Weitlaner Retractor
3x4th 6 1/2" Blunt

G13-09
Weitlaner Retractor 8"
Blunt 3x4 Prongs

G13-230
Weitlaner Retractor 9 1/2"
Blunt 3x4 Prongs

G13-231
Weitlaner Retractor 9 1/2"
Sharp 3x4 Prongs



G13-94
Weitlaner Retractor 5 1/2"
Blunt

G13-93
Weitlaner Retractor 5 1/2"
Sharp 3x4 Prongs

G13-10
Weitlaner Retractor Sharp,
3x4th 6 1/2"

G13-11
Weitlaner Retractor 8" Sharp
3x4 Prongs



G13-02
Balfour Abdominal Retractor
10" Spread, Standard

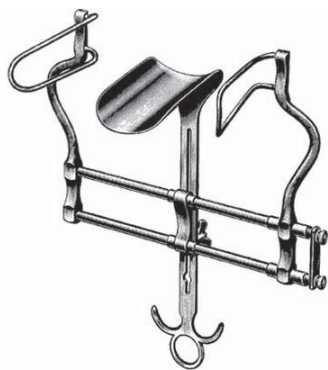

G13-05
Balfour Abdominal Retractor
7" Spread



G13-195
Balfour Abdominal, solid side
blades 2 3/4" deep, and solid
center blade 3" x 7" Spread

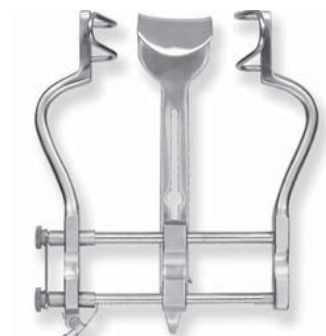

G13-197
Balfour Abdominal Retractor 5
1/4" Spread, 2" x 1.65" Blade



G13-04
 Pediatric Balfour Abdominal Retractors With Fenestrated Side Blades And Solid Center Blade 1" deep, 4" Spread,
 G13-06
 Balfour Pediatric Retractor,
 3 1/2" Spread



G10-97
 Beeson Cast Spreader 12 1/4"



G10-78
 Cast Spreader Walton 9"

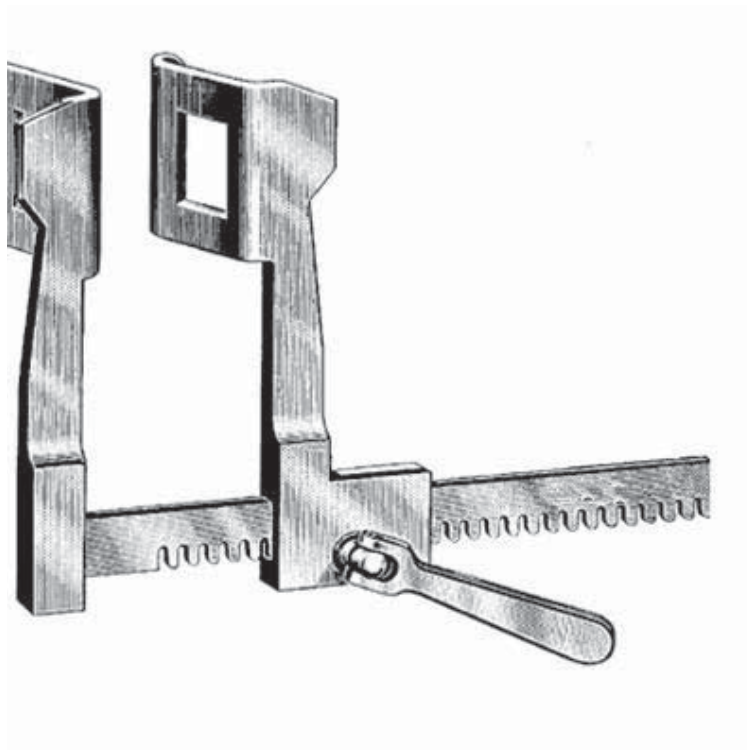

G45-060
 Finochietto Rib Spreader,
 Original Model, Standard Size,
 blades 48mm deep x 65mm
 wide, 8" Spread,

G45-062
 Finochietto Rib Spreader,
 Original Model, Standard Size,
 blades 48mm deep x 65mm
 wide, 10" Spread, Curved arms.

G45-064
 Finochietto Rib Spreader,
 Original Model, Standard Size,
 blades 48mm deep x 65mm
 wide, 12" Spread, Curved arms.

Retractors



G18-339
Goldstein Eye Retractor, 3x3
pointed prongs, 5mm Deep 1 1/8"



G13-255
Gossett Abdominal Retractor,
5.5"



G13-601
Holzheimer Retractor 4"
4x4 Prongs Sharp
G13-603
Holzheimer Retractor 4"
4x4 Prongs Blunt



G13-189
Gelbi Retractor With Grip Lock
6 3/4"



G13-58
Gelbi Retractor 4 1/2" Right
Angled
G13-58R
Gelbi Retractor Right Angled 5
1/2"



G80-1981
Gelbi Retractor 3 1/2"
G80-1983
Gelbi Retractor 4 1/2"
G13-110
Gelbi Retractor 5 1/4"
G13-59
Gelbi Retractor 7"



G46-59
Hudson Brace, Small

G46-58
Hudson Brace, Large

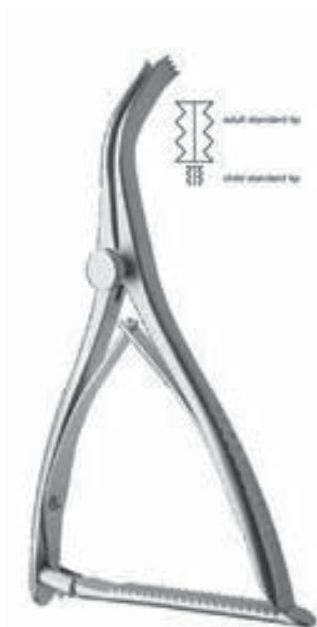

G46-392
Inge Retractor, 6 1/2"

G46-393
Inge Retractor, 11"



G13-30
Meyerding Retractor, 89mm X
50mm Blade, Large, 10"

G13-31
Meyerding Retractor, 75mmX-
25mm Blade, Medium, 10"

G13-32
Meyerding Retractor, 52mmX-
16mm Blade, Small, 10"



G18-90-03
Davis Stifle Retractor 7"
With Speed Lock, Cross Action



G18-90-01
Modified Stifle Retractor 18cm



G13-143
Ragnell Retractor 6" D/E

Retractors

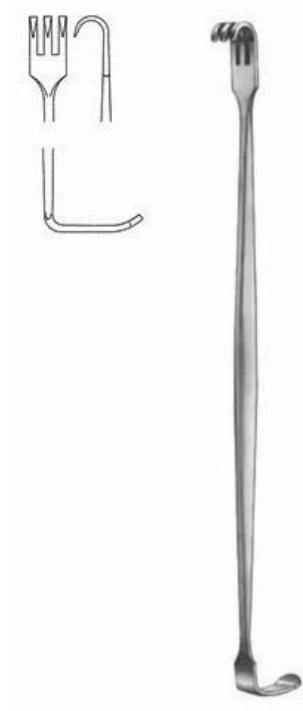

G13-38
Senn Retractor 3 Prongs Sharp
6 1/4"

G13-39
Senn Retractor 3 Prongs Blunt
6 1/4"



G13-65
Ribbon Retractor,
Malleable 1.0", 13"

G13-66
Ribbon Retractor,
Malleable 1.25", 13"

G13-67
Ribbon Retractor,
Malleable 1.5", 13"

G13-68
Ribbon Retractor,
Malleable 2.0", 13"

G13-72
Ribbon Retractor,
Malleable 2.5", 13"

G13-73
Ribbon Retractor,
Malleable 3.0", 13"

G13-265
Ribbon Retractor,
Malleable .75", 13"



G18-90-02
Small Stifle Retractor 5"
With Speed Lock, Cross Action



G22-805
Wallace Knee Retractor, 5"



G13-607
Lahey Retractor 1 Sharp Prong, 4 3/4"
G13-609
Lahey Retractor 2 Sharp Prongs, 4 3/4"
G13-611
Lahey Retractor 3 Sharp Prongs, 4 3/4"



G24-830
Ruskin Rongeur 4x15mm Bite
Straight 7 1/4"
G24-836
Ruskin Rongeur 4x15mm Bite
Curved 7 1/4"

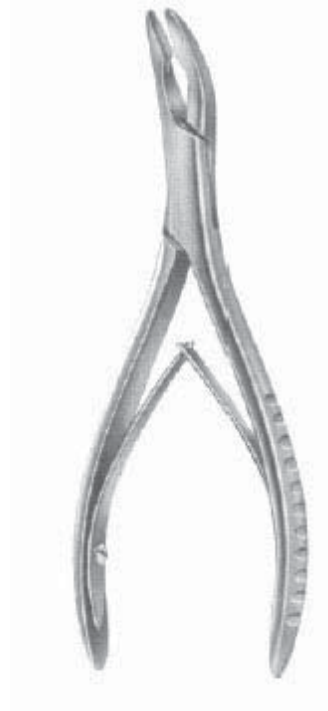

G24-350
Dean Rongeur 3mm x 10mm
Bite Curved, 5 3/4"



G19-182
Ruskin Rongeur 3x10mm
Bite Curved 6"



G46-227
Ferris Smith Rongeur 7" 6mmx-
10mm Straight
G46-228
Ferris Smith Rongeur 7" 4mmx-
10mm Up Angle
G46-230
Ferris Smith Rongeur 7" 6mmx-
12mm Straight
G46-642
Ferris Smith Rongeur 7" 6mmx-
10mm Up Angle
G46-644
Ferris Smith Rongeur 7" 6mmx-
10mm Down Angle



G46-191
Kerrison Rongeur 7" 1mm Up-
Bite
G46-193
Kerrison Rongeur 7" 1mm
Down-Bite
G46-175
Kerrison Rongeur 7" 2mm Up-
Bite
G46-176
Kerrison Rongeur 7" 3mm Up-
Bit Thin Foot Plate 40 Degree

Rongeurs

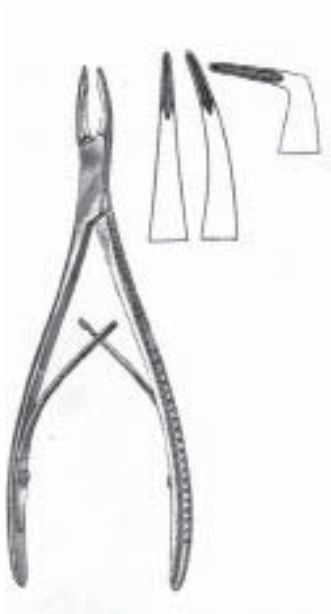

GD50-151
Micro Friedman Rongeurs, Curved
Jaws, angled 15 Degrees, 5 1/2"

GD50-152
Micro Friedman Rongeurs, Curved
Jaws, Angled, 90 Degrees, 5 1/2"



G24-758
Adson Rongeur
17 x 7mm Bite Straight, 8"

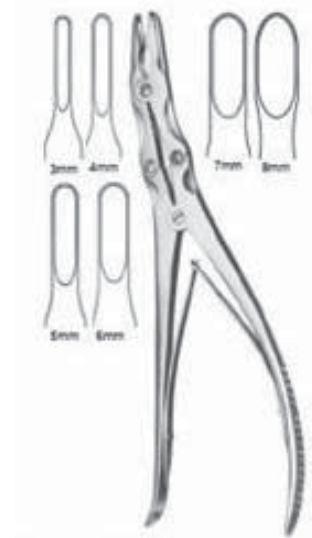

G19-76
Lempert Rongeur
2.5mm x 10mm Bite Straight 6 1/2"

G19-77
Lempert Rongeur
2.5mm x 10mm Bite Curved 6 1/2"

G24-808
Leksell Rongeur 9" 4x16mm
Bite Angled

G24-814
Leksell Rongeur 9" 7x16mm
Bite Angled

Scissors



G10-500
Canine Ear Cropping Scissors
6 1/2" Straight- S/B

G10-501
Canine Ear Cropping Scissors
6 1/2" Curved- S/B

G10-505
Canine Ear Cropping Scissors
6 1/2" Straight- B/B

G10-506
Canine Ear Cropping Scissors
6 1/2" Curved- B/B



G10-104
Baby Metzenbaum Scissors,
Standard Straight, 4 1/2"

G10-105
Baby Metzenbaum Scissors,
Standard Curved 4 1/2"



G18-238
Stitch Scissors Blunt Blades 3
3/4" Curved, Fine Tips

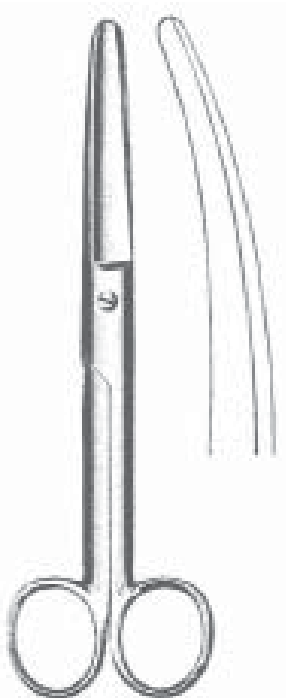

G10-114
Doyen Abdominal Scissors, 7"
straight
G10-115
Doyen Abdominal Scissors, 7"
curved



G10-09
Emergency Room Shears,
8 1/2" serrated edge



G10-26
Mayo Dissecting Scissors,
Straight 5 1/2"

G10-28
Mayo Dissecting Scissors
Curved 5 1/2"

G10-27
Mayo Dissecting Scissors
Straight 6 3/4"

G10-29
Mayo Dissecting Scissors,
Curved, 6 3/4"

G10-67
Mayo Dissecting Scissors,
9" straight

G10-68
Mayo Dissecting Scissors
Curved 9"

Scissors



G10-SC-130
Ragnell Dissecting Scissors
Straight 5" Supercut
G10-SC-163
Ragnell Dissecting Scissors Flat tip
Curved 7" Supercut



G10-1000
Operating Scissors Standard pattern
straight, Sharp/Sharp, 4 1/2"

G10-1100
Operating Scissors Standard pattern,
straight, Sharp/Sharp, 5"

G10-1200
Operating Scissors Standard Pattern
Straight, Sharp/Sharp 5 1/2"

G10-1400
Operating Scissors Standard pattern,
straight, Sharp/Sharp, 6 1/2"

G10-1300
Operating Scissors Standard pattern,
straight, Sharp/Sharp, 6"



G10-1501
Operating Scissors Standard
pattern, curved, Sharp/Blunt,

G10-1601
Operating Scissors Standard
pattern, curved, Sharp/Blunt, 5"

G10-1701
Operating Scissors Standard
pattern, curved, Sharp/Blunt, 5

G10-1801
Operating Scissors Standard
pattern, curved, Sharp/ Blunt, 6"

G10-1901
Operating Scissors Standard
pattern, curved, Sharp/Blunt, 6

G10-2101
Operating Scissors Standard
pattern, curved, Sharp/Blunt, 7

Scissors

G10-1500
Operating Scissors Standard pattern, curved, Sharp/Sharp, 4 1/2"



G10-1600
Operating Scissors Standard pattern, curved, Sharp/Sharp, 5"

G10-1700
Operating Scissors Standard pattern, curved, Sharp/Sharp, 5 1/2"

G10-1800
Operating Scissors Standard pattern, curved, Sharp/Sharp, 6"

G10-1900
Operating Scissors Standard pattern, curved, Sharp/Sharp, 6 1/2"



GD50-263
Iris Scissors, Straight Tungsten Carbide, 4 1/2"
GD50-265
Iris Scissors, Curved Tungsten Carbide, 4 1/2"



G10-1001
Operating Scissors Standard pattern, straight, Sharp/Blunt 4 1/2"

G10-1101
Operating Scissors Standard pattern, straight, Sharp/Blunt, 5"

G10-1201
Operating Scissors Standard pattern, Straight, Sharp/Blunt, 5 1/2"

G10-1301
Operating Scissors Standard pattern, straight, 6"

G10-1401
Operating Scissors Standard pattern, straight, Sharp/Blunt 6 1/2"

G10-2001
Operating Scissors Standard pattern, straight, Sharp/Blunt, 7 1/2"

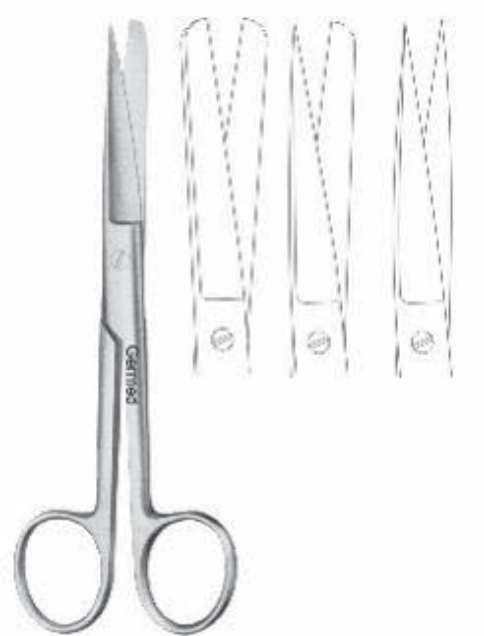

G10-1002
Operating Scissors Standard pattern, straight, Blunt/Blunt, 4 1/2"

G10-1102
Operating Scissors Standard pattern, straight, Blunt/Blunt, 5"

G10-1202
Operating Scissors Standard pattern, straight, Blunt/Blunt, 5 1/2"

G10-1302
Operating Scissors Standard pattern, straight, Blunt/Blunt, 6"

G10-1402
Operating Scissors Standard pattern, straight, Blunt/Blunt, 6 1/2"



G10-1502
Operating Scissors, Standard pattern, curved, Blunt/Blunt, 4

G10-1602
Operating Scissors, Standard pattern, curved, Blunt/Blunt 5"

G10-1702
Operating Scissors, Standard pattern, curved, Blunt/Blunt, 5 1/2"

G10-1802
Operating Scissors, Curved, Blunt/Blunt, 6"

G10-1902
Operating Scissors, Curved Blunt/Blunt, 6 1/2"

Scissors

G10-SC-1700
Operating Scissors Standard Pattern, sharp/sharp, Curved 5 1/2"

G10-SC-1200
Operating Scissors Standard Pattern, sharp/sharp, Straight 5 1/2", Supercut

G10-SC-1202
Operating Scissors Standard pattern, straight, Blunt/Blunt, 5 1/2", Supercut

G10-SC-1201
Operating Scissors Standard pattern, Straight, Sharp/Blunt, 5 1/2", Supercut

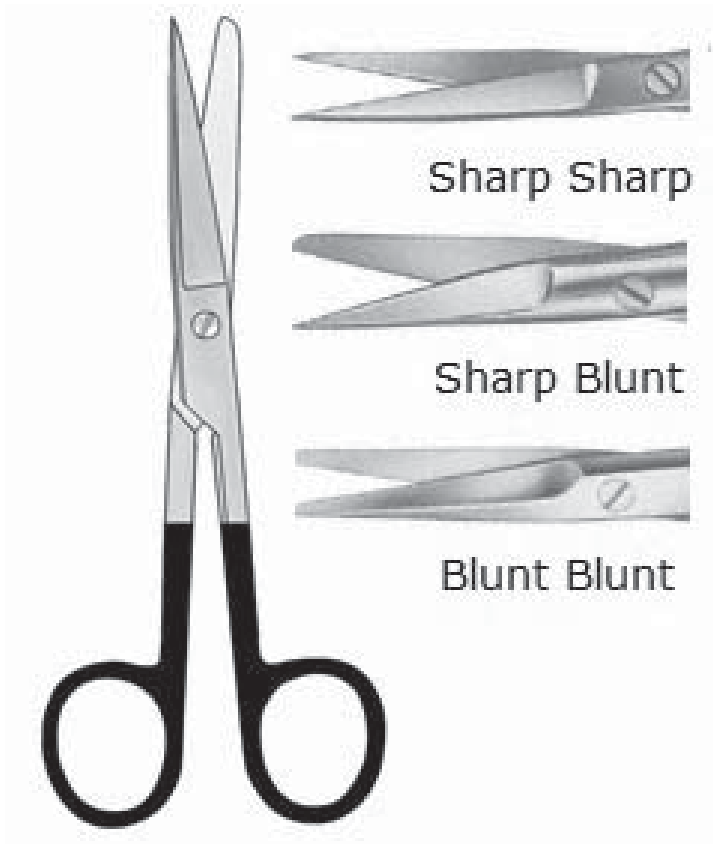

G17-1203
Gradle Scissors Curved 3 3/4"

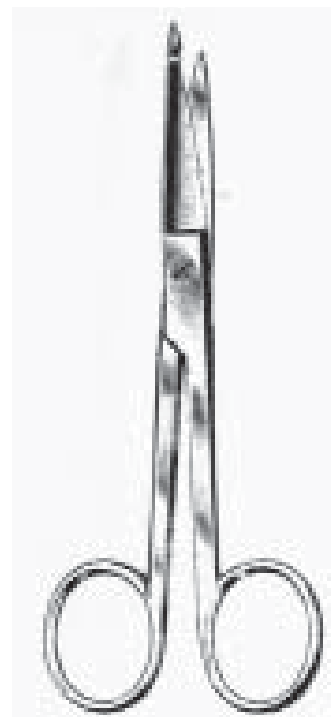

G10-71
Knowles Bandage Scissors,
Straight 5 1/2"

Scissors



G10-01
Lister Bandage Scissors
3 1/2"

G10-05
Lister Bandage Scissors
8" With One Large Ring.

G10-02
Lister Bandage Scissors
4 1/2"

G10-107
Lister Bandage Scissors
8"

G10-03
Lister Bandage Scissors
5 1/2"

G10-04
Lister Bandage Scissors
7 1/4"



G10-06
Hi-Level Bandage Scissors,
Angled 5 1/2"



G10-07
Feline Bandage Scissors, 7"



G18-394
Iris Scissors 3 1/2" , Curved,
Blunt Points

G18-393
Iris Scissors 3 1/2" Straight,
With Blunt Points

G18-256
Iris Scissors, 3 1/2" Straight,
With Sharp Tips

G18-257
Iris Scissors, 3 1/2" Curved,
With Sharp Tips

G18-248
Iris Scissors, 4" Straight, With-
Sharp Points

G18-246
Iris Scissors, 4" Curved, With-
Sharp Points

G10-44
Iris Scissors, 4 1/2", Straight,
With Sharp Points

G10-45
Iris Scissors 4 1/2" Curved,
With Sharp Tips



G10-141
Metzenbaum Dissecting Scissors Str
5" Delicate

G10-153
Metzenbaum Dissecting Scissors Str 6"
Delicate

G10-154
Metzenbaum Dissecting Scissors, Deli-
cate, 7" straight

G10-40
Metzenbaum Dissecting Scissors Curved
8" Delicate

G10-143
Metzenbaum Dissecting, Delicate,
9" straight



G22-47
Metzenbaum Scissors (Lahey),
Straight, 5.75", Standard

G22-48
Metzenbaum Scissors (Lahey),
Curved, 5.75", Standard

G10-208
Metzenbaum Scissors (Lahey),
Pedifine Curved, 4 1/2", Stan-

G10-212
Metzenbaum Scissors (Lahey),
Pedifine Straight, 4 1/2"

Scissors



G10-36
Metzenbaum Scissors 5 1/2"
Straight, Standard

G10-133
Metzenbaum Dissecting
Scissors Straight 5"

G10-137
Metzenbaum Dissecting
Scissors Curved 5"

G10-37
Metzenbaum Scissors
Straight 7"

G10-39
Metzenbaum Dissecting
Scissors Curved 7"

G10-146
Metzenbaum Scissors
Curved 8"

G10-134
Metzenbaum Scissors
Straight 9"

G10-138
Metzenbaum Scissors
Curved 9"

G10-136
Metzenbaum Scissors
Straight 14 1/2"



G10-120
Metzenbaum Scissors (Nelson),
Straight Delicate, 7", Tungsten

G10-216
Metzenbaum Scissors (Nelson),
Curved, 7", Standard

G10-226
Metzenbaum Scissors (Nelson),
Straight, 7", Standard

G10-218
Metzenbaum Scissors (Nelson),
Curved, 8", Standard

G10-228
Metzenbaum Scissors (Nelson),
Straight, 8", Standard

G10-222
Metzenbaum Scissors (Nelson),
Straight, 9", Standard

G10-119
Metzenbaum Scissors (Nelson),
Curved, 9", Standard

G10-224
Metzenbaum Scissors (Nelson),
Straight, 10", Standard

G10-2150
Metzenbaum Scissors (Nelson),
Curved, 10", Standard

G10-225
Metzenbaum Scissors (Nelson),
Straight, 11", Standard

G10-139
Metzenbaum Scissors (Nelson),
Curved, 11", Standard



G17-205
Metzenbaum Scissors (Lahey), Curved
Delicate, 5.75", Tungsten Carbide

G17-206
Metzenbaum Scissors (Lahey), Curved
Sharp-Sharp, 5.75", Tungsten Carbide

G17-207
Metzenbaum Scissors (Lahey), Curved
Standard, 5.75", Tungsten Carbide

G17-209
Metzenbaum Scissors (Lahey), Straight
Delicate, 5.75", Tungsten Carbide

G17-211
Metzenbaum Scissors (Lahey), Straight
Standard, 5.75", Tungsten Carbide

G17-213
Metzenbaum Scissors (Lahey), Straight
Sharp-Sharp, 5.75", Tungsten Carbide



G17-214
Metzenbaum Scissors (Nelson),
Curved Delicate, 7", Tungsten

G17-217
Metzenbaum Scissors (Nelson),
Curved, 7", Tungsten Carbide

G17-227
Metzenbaum Scissors (Nelson),
Straight, 7", Tungsten Carbide

G17-223
Metzenbaum Scissors (Nel-
son), Straight, 9", Tungsten

G17-219
Metzenbaum Scissors (Nelson),
Straight Delicate, 9", Tungsten

G17-215
Metzenbaum Scissors (Nelson),
Curved Delicate, 9", Tungsten

Scissors

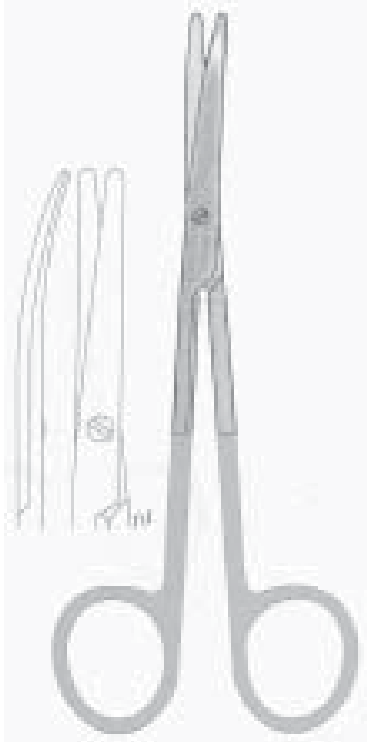

G17-17
Metzenbaum Scissors Tungsten Carbide
Insert, Standard, curved, 5 1/2"/ 14.5 cm

G17-32
Metzenbaum Scissors, Tungsten Carbide
Insert, Delicate, Curved, 5 1/2"/ 14.5 cm

G17-29
Metzenbaum Scissors, Tungsten Carbide
Insert, Delicate, Straight, 5 1/2"/ 14.5 cm

G17-18
Metzenbaum Scissors Tungsten Carbide
Insert, Standard, Curved, 7"/ 17.5 cm

G17-31
Metzenbaum Scissors, Tungsten Carbide
Insert, Delicate, Straight, 9"/ 22.5m

G17-30
Metzenbaum Scissors, Tungsten
Carbide Insert, Delicate, Straight,
7" 17.5 cm

G17-33
Metzenbaum Scissors, Tungsten
Carbide Insert, Delicate, Curved, 7"

G17-19
Metzenbaum Scissors Tungsten
Carbide Insert, Standard, Curved, 8"/

G17-34
Metzenbaum Scissors, Tungsten
Carbide Insert, Delicate, Curved, 9"

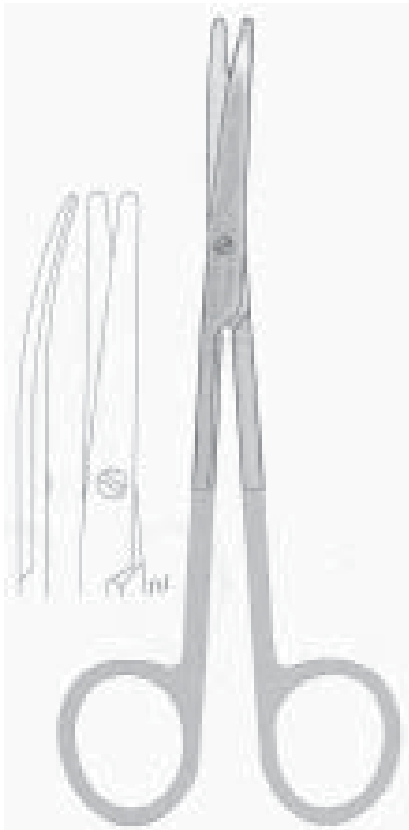

G17-13
Metzenbaum Scissors Tungsten
Carbide Insert, Straight, 5 1/2"/ 14.5

G17-14
Metzenbaum Scissors, Tungsten
Carbide Insert, Standard, Straight,
7"/ 17.5 cm

G17-15
Metzenbaum Scissors, Tungsten
Carbide Insert, Standard, Straight,
8"/ 20 cm

G17-16
Metzenbaum Scissors, Tungsten
Carbide Insert, Standard, Straight,
9"/ 22.5 cm

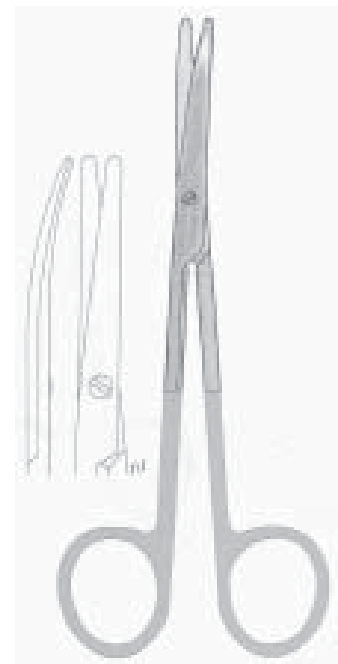

G17-120
Metzenbaum Scissors, Tungsten
Carbide Insert, Standard, Curved,
11"/ 27.5 cm



G17-10
Mayo Dissecting Scissors 6 3/4"
Straight Tungsten Carbide

G17-12
Mayo Dissecting Scissors 6
3/4" Curved Tungsten Carbide

G17-113
Mayo Dissecting Scissors,
Tungsten Carbide Insert, Curved, 9"

G17-112
Mayo Dissecting Scissors,
Tungsten Carbide Insert, Straight, 9"



G17-06
Mayo Stille Scissors, Tungsten
Carbide Insert, Straight, 6 3/4"

G17-08
Mayo Stille Scissors, Tungsten
Carbide Insert, Curved, 6 3/4"

G17-09
Mayo Dissecting Scissors 5
1/2" Straight Tungsten Carbide

G17-11
Mayo Dissecting Scissors 5 1/2"
Curved Tungsten Carbide



G17-1200
Goldman Fox, Curved 5",
Tungsten Carbide



G17-35
Operating Scissors, Straight, Blunt/
Blunt Tungsten Carbide 5 1/2"

G17-38
Operating Scissors, Tungsten Carbide
Insert, curved, blunt/blunt, 5 1/2"

G17-37
Operating Scissors, Straight, Sharp/
Sharp Tungsten Carbide 5 1/2"

G17-36
Operating Scissors, Straight, Sharp-
Blunt Tungsten Carbide 5 1/2"

G17-390
Operating Scissors, Tungsten Carbide
Insert, curved, sharp/blunt, 5 1/2"

G17-40
Operating Scissors, Tungsten Carbide
Insert, curved, sharp/sharp, 5 1/2"

Scissors

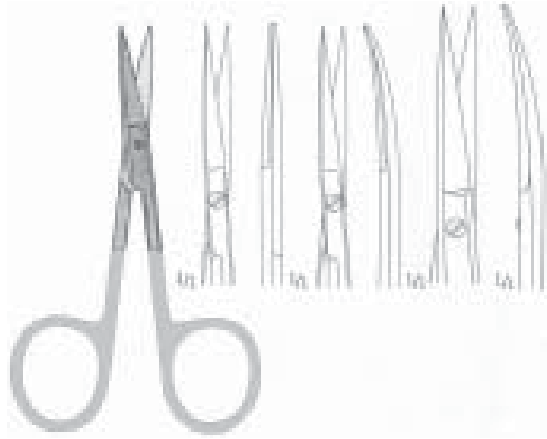

G17-01
Iris Scissors, Tungsten Carbide
Inserts, Straight, 4 1/2" / 11.5 cm

G17-02
Iris Scissors, Tungsten Carbide
Inserts, Curved, 4 1/2" / 11.5 cm



GD50-SC-766
Goldman Fox Scissors, Curved
5", SUPERCUT

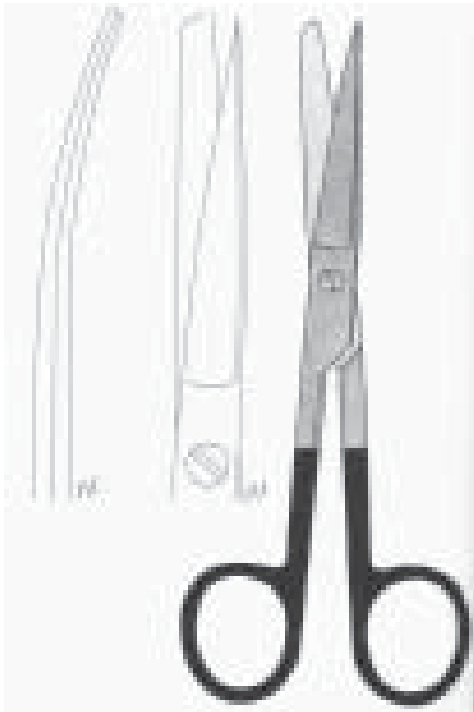

G10-SC-28
Mayo Dissecting Scissors Curved
5 1/2" SUPERCUT

G10-SC-26
Mayo Dissecting Scissors Straight,
5 1/2" SUPERCUT

G10-SC-29
Mayo Dissecting Scissors Curved
6 3/4" SUPERCUT

G10-SC-27
Mayo Dissecting Scissors Straight,
6 3/4" SUPERCUT

G10-SC-69
Mayo Dissecting Scissors 7"
Curved SUPERCUT

G10-SC-67
Mayo Dissecting Scissors 9"
Straight SUPERCUT



G18-SC-387
Gradle Scissors, Curved 3 3/4",
SUPERCUT



G10-SC-44
Iris Scissors, Straight Supercut,
4 1/2"
G10-SC-45
Iris Scissors, Curved Supercut,
4 1/2"



G10-SC-100
Baby Metzenbaum Scissors, Supercut,
Curved, 4 1/2" Supercut
G10-SC-105
Baby Metzenbaum Scissors, Supercut,
Straight, 4 1/2", Supercut



G10-SC-140
Metzenbaum Curved 4 1/2"
Supercut



G10-SC-136
Metzenbaum Straight 4 1/2"
Supercut

G10-SC-137
Metzenbaum Scissors 5"
Curved, Supercut

G10-SC-38
Metzenbaum Scissors 5 1/2"
Curved Supercut

G10-SC-145
Metzenbaum Dissecting Scissors
Delicate Curved 5 3/4" (Lahey)
SUPERCUT

G10-SC-36
Metzenbaum Scissors 5 1/2"
Straight, Supercut

G10-SC-229
Metzenbaum Scissors, Supercut,
Curved, 5 1/2"

G10-SC-230
Metzenbaum Scissors, Supercut,
Straight, 5 1/2"

G10-SC-39
Metzenbaum Scissors 7"
Curved, Supercut

G10-SC-37
Metzenbaum Scissors, Supercut,
Straight, 7"

G10-SC-154
Metzenbaum Dissecting Scissors
Delicate Straight 7" SUPERCUT

G10-SC-129
Metzenbaum Dissecting Scissors
Delicate Curved 7" Supercut

G10-SC-143
Metzenbaum Dissecting Scissors
Delicate Straight 9" SUPERCUT

G10-SC-119
Metzenbaum Dissecting Scissors
Delicate Curved 9" (Nelson) Supercut

Scissors



G10-41
Spencer Stitch Scissors 3 1/2"
G10-54
Spencer Stitch Scissors 3 1/2"
Delicate
G10-52
Spencer Stitch Scissors, 4 3/4"

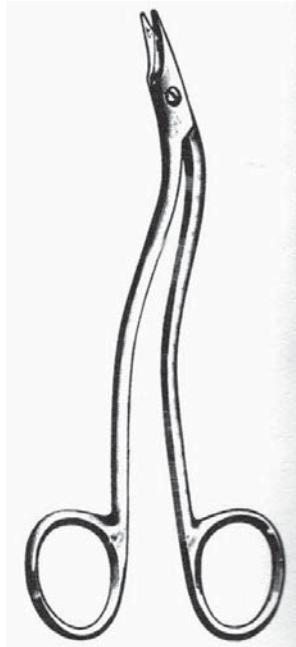

GD50-413
Suture Scissors, Long, 6 1/4"



G10-43
Littauer Stitch Scissors, 5 1/2" Straight
G10-51
Littauer Stitch Scissors, 4 1/2" straight



G10-42
Northbent Stitch Scissors 3 1/2"
G10-42A
Northbent Stitch Scissors,
Curved Sideways, 4 1/2"



G10-50
Wire Cutting Scissors 4 3/4"
Angled, One Serrated Blade



G10-605
Roger Wire Cutting Scissors, Serrated
Angular, 4 3/4", Tungsten Carbide

G10-603
Roger Wire Cutting Scissors, Serrated
Angular Carbide Edge, 4 3/4"



G10-604
Wire Cutting Scissors, Straight,
4 1/4"



G20-06
Killian Canine Speculum 2"

G20-08
Killian Canine Speculum 3"

G20-09
Killian Canine Speculum 3 1/2"

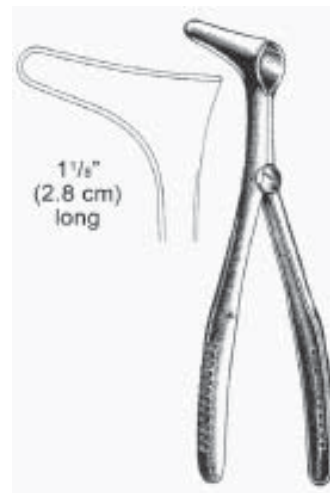

G20-01
Vienna Felina Vaginal Speculum,
Small

G20-02
Vienna Felina Vaginal Speculum,
Medium

G20-03
Vienna Felina Vaginal Specu-
lum, Large

Sterile Surgical Blades

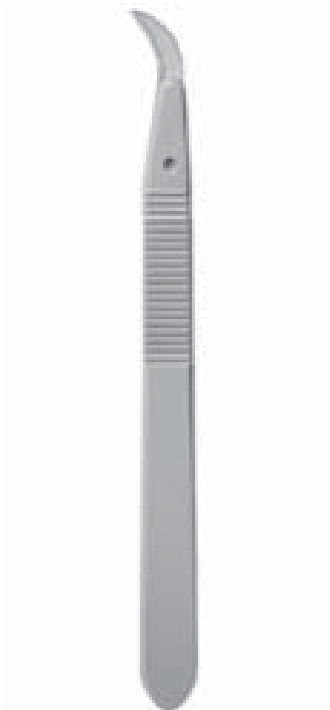

G08-45
Disposable Scalpel, Stainless Steel
Blade, Plastic Handle, Size 12

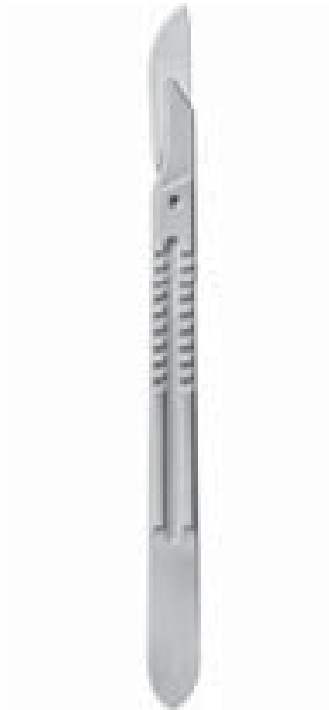

G08-48
Disposable Scalpels, Stainless
Steel Blade, Plastic Handle, Size 21



G08-43
Sterile Surgical Blades, Box of
100, Stainless Steel, Size 9

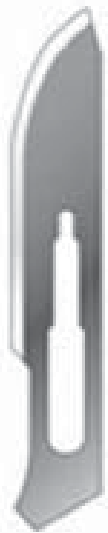

G08-20
Sterile Surgical Blades, Box of
100, Carbon Steel Size 10



G08-21
Sterile Surgical Blades, Box of
100, Carbon Steel Size 11



G08-22
Sterile Surgical Blades, Box of
100, Carbon Steel Size 12



G08-23
Sterile Surgical Blades, Box of
100, Carbon Steel Size 12B



G08-24
Sterile Surgical Blades, Box of
100, Carbon Steel Size 15



G08-25
Sterile Surgical Blades, Box of
100, Carbon Steel Size 15C



G08-26
Sterile Surgical Blades, Box of
100, Carbon Steel Size 20



G08-27
Sterile Surgical Blades, Box of
100, Carbon Steel Size 21



G08-28
Sterile Surgical Blades, Box of
100, Carbon Steel Size 22



G08-29
Sterile Surgical Blades, Box of
100, Carbon Steel Size 23

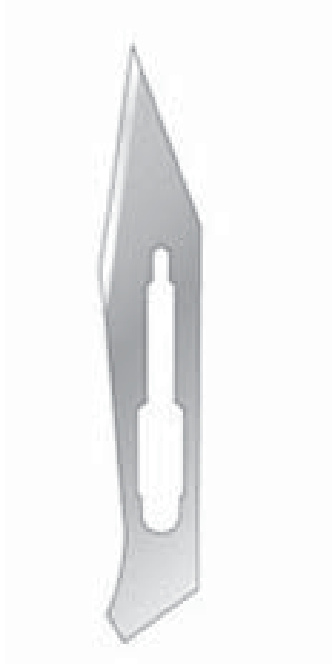

G08-30
Sterile Surgical Blades, Box of
100, Carbon Steel Size 25



G08-34
Sterile Surgical Blades, Box of
100, Stainless Steel, Size 12

Sterile Surgical Blades

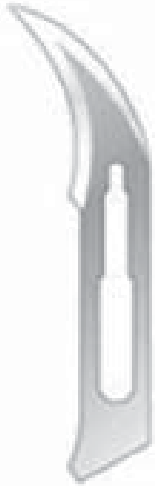

G08-35
Sterile Surgical Blades, Box of
100, Stainless Steel, Size 12B



G08-36
Sterile Surgical Blades, Box of
100, Stainless Steel, Size 15



G08-33
Sterile Surgical Blades, Box of
100, Stainless Steel, Size 11



G08-37
Sterile Surgical Blades, Box of
100, Stainless Steel, Size 15C



G08-38
Sterile Surgical Blades, Box of
100, Stainless Steel, Size 20



G08-39
Sterile Surgical Blades, Box of
100, Stainless Steel, Size 21



G08-40
Sterile Surgical Blades, Box of
100, Stainless Steel, Size 22



G08-41
Sterile Surgical Blades, Box of
100, Stainless Steel, Size 23



G08-42
Sterile Surgical Blades, Box of
100, Stainless Steel, Size 25

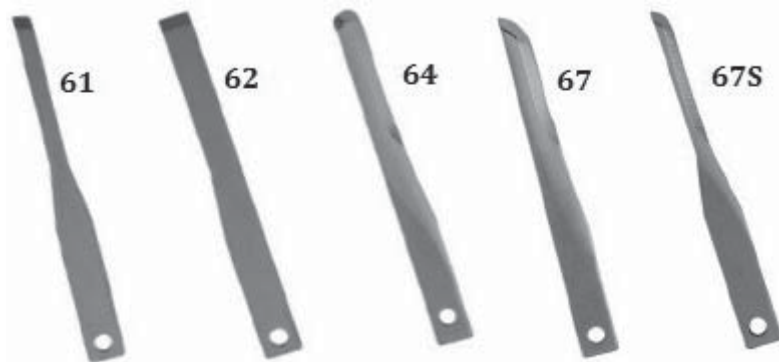

G08-61
Sterile Surgical Blade Beaver,
Style 61, 12/Box

G08-62
Sterile Surgical Blade Beaver,
Style 62, 12/Box

G08-64
Sterile Surgical Blade Beaver,
Style 64, 12/Box

G08-67S
Sterile Surgical Blade Beaver,
Style 67 Slim, 12/Box

G08-67
Sterile Surgical Blade Beaver,
Style 67, 12/Box

Surgical Needles



G17-80-24
Heavy Duty Cruciate Needle
Driver, Tungsten Carbide



GD20-169
Keith Abdominal Surgical
Needle, Straight Triangular Point

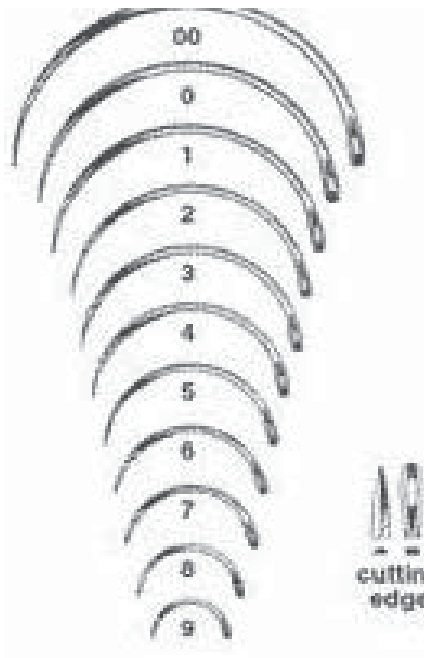

GD20-162
Surgical Needle, Circle, Cutting
Edge, Regular Eye



GD20-164
Surgical Needle, Circle Cutting
Edge, Veterinary Heavy Pattern

Surgical Needles



GD20-166
Loopuyt Surgical Needle,
Cutting Edge

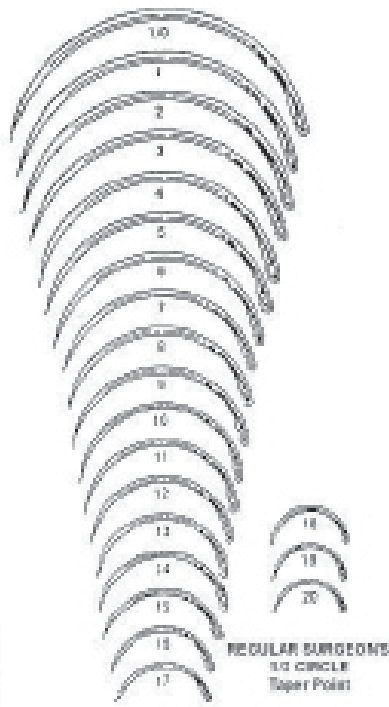

GD20-156
Surgical Needle, 1/2 Circle
Cutting Edge

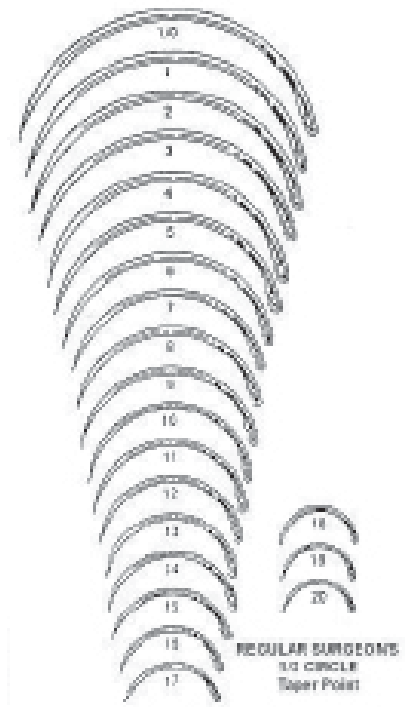

GD20-157
Surgical Needle, 1/2 Circle Cutting
Edge, Regular Surgeons



GD20-165
Surgical Needle, Half Circle
Cutting Edge, Veterinary Heavy



GD20-161
Surgical Needle, Half Circle,
Cutting Edge

Surgical Needles

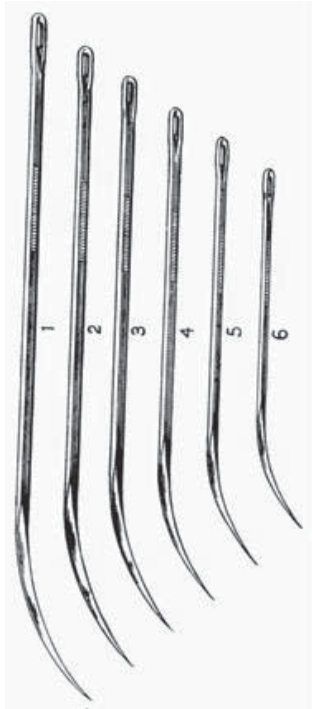

GD20-167
Surgical Needle, Half Curved
Heavy pattern, Cutting Edge



GD20-159
Surgical Needle, Half Curved,
Cutting Edge, Regular

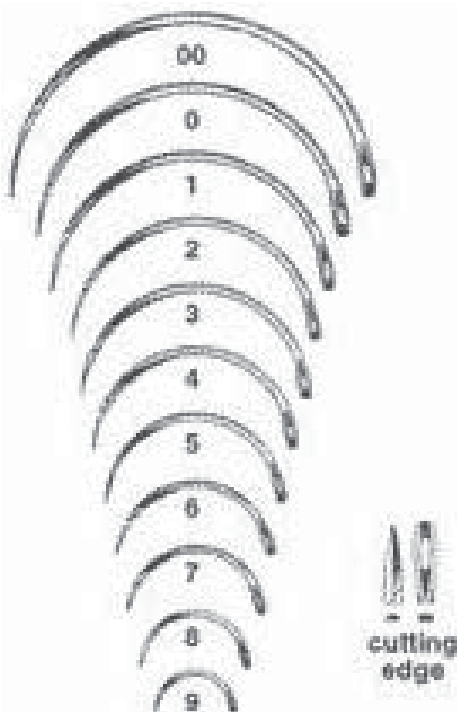

GD20-163
Surgical Needle, Regular Eye

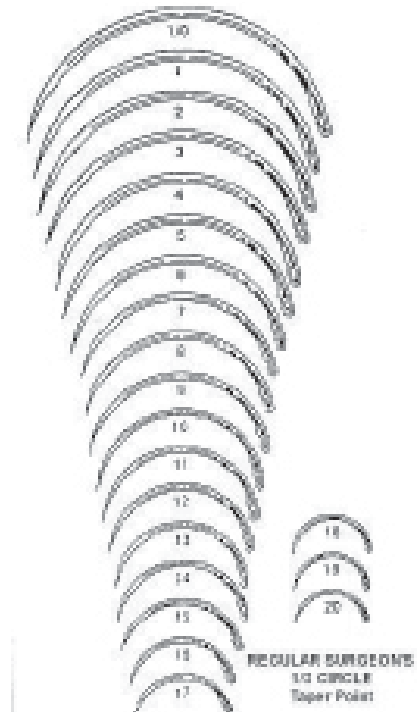

GD20-158
Surgical Needle, Spring Eye



GD20-168
Surgical Needle, Double curved
Heavy Pattern



GD20-160
Surgical Needle, Spring Eye



GD20-163-01
Surgical Needle, With spring eye

Suture



G18-158
Bonn Suture Forceps, 0.12
For Microsurgery

Suture

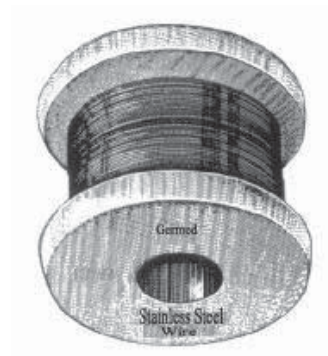

GD50-1055
Stainless Steel, 18 Guage, Dia
.040"

GD50-1057
Stainless Steel, 20 Guage, Dia
.032"

GD50-1059
Stainless Steel, 22 Guage, Dia
.025"

GD50-1062
Stainless Steel, 24 Guage, Dia
.020"

GD50-1064
Stainless Steel, 25 Guage, Dia
.018"

GD50-1066
Stainless Steel, 26 Guage, Dia
.016"

GD50-1068
Stainless Steel, 28 Guage, Dia
.012"

GD50-1071
Stainless Steel, 30 Guage, Dia
.010"

GD50-1073
Stainless Steel, 32 Guage, Dia
.008"

GD50-1075
Stainless Steel, 34 Guage, Dia
.006"

GD50-1077
Stainless Steel, 36 Guage, Dia
.005"

GD50-1079
Stainless Steel, 38 Guage, Dia
.004"

GD50-1082
Stainless Steel, 40 Guage, Dia
.003"

Thoracic Forceps

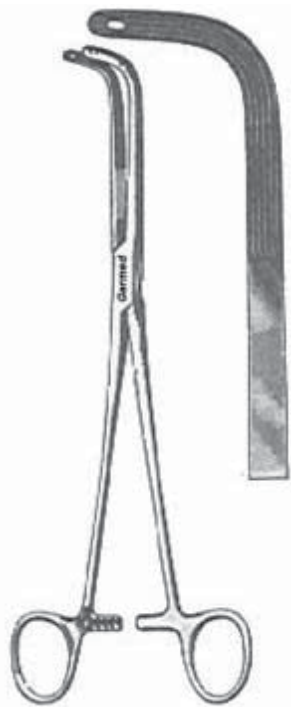

G45-436
Finochietto Thoracic Forceps,
slightly curved jaws, 9"

G45-438
Finochietto Thoracic Forceps and
Ligature Carrier 9 1/2", angular
jaws longitudinal serrations

Towel Clamps & Sponge Forceps



G11-26
Backhaus Towel Clamp, 3 1/2"

G11-64
Backhaus Towel Clamps 4 1/2"

G11-27
Backhaus Towel Clamp, 5 1/4"



G7-20-H
Hoff Non Perforated Towel Clamp
5 1/4"

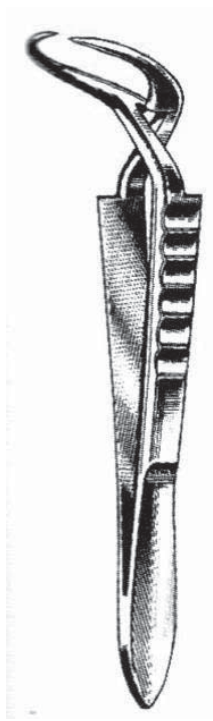

G11-138
Jones Towel Clamp,
Light Weight 2 1/4"
G11-137
Jones Towel Clamp, 3"

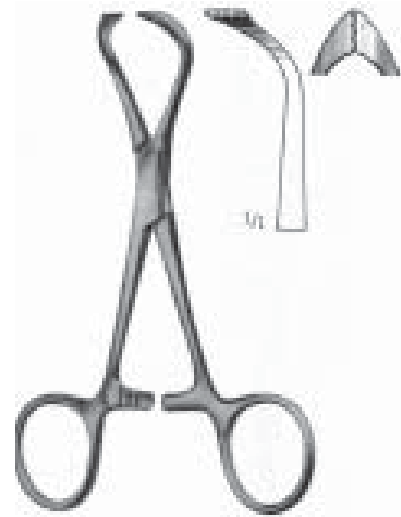

G11-139
Lorna Non-Perforated Towel
Clamp 3 1/2"
G11-140
Lorna Edna Towel Clamp,
Non-Perforating, 5 1/4"



G11-11
Foerster Sponge Forceps, Serrated
Jaws Straight, 7"

G11-12
Foerster Sponge Forceps, Serrated
Jaws Curved, 7"

G11-13
Foerster Sponge Forceps, Serrated
Jaws Straight, 9 1/2"

G11-14
Foerster Sponge Forceps, Serrated
Jaws Curved, 9 1/2"



G11-179
Young Tongue Forceps,
Interchangeable rubber jaw, 6 1/2"

INDEX

A

Adson Bayonet Dressing Forceps, Serrated, 8 1/4".....	22
Adson Cranial Rongeur, curved jaws 7 x 13 mm, Size 8".....	50
Adson Cranial Rongeur, Straight jaws 7 x 13 mm, Size 8".....	50
Adson Dressing Forceps 4 3/4" Serrated.....	22
Adson Dressing Forceps, Delicate, Serrated Jaws 4 3/4".....	22
Adson Forceps 4 3/4" 1x2th.....	22
Adson Forceps 4 3/4" Micro With 1x2th.....	23
Adson Forceps 4 3/4" Micro With Serrations.....	23
Adson Forceps, Curved, 7 1/4".....	40
Adson Forceps, Straight, 7 1/4".....	40
Adson Rongeur 17 x 7mm Bite Straight, 8".....	86
Adson Tissue and Suture Forceps, 4 3/4", tying platform.....	23
Adson Tissue Forceps, 1x2 with Carbide Suture Platform.....	23
Adson Tissue Forceps, 2x3 Teeth Delicate, 4 3/4".....	23
Adson Tissue Forceps, Cross Serrated Atraumatic.....	24
Adson-Brown Forceps, 9x9 teeth, side grasp, 4 3/4".....	24
Advanced Rabbit Dental Pack.....	73
Allis Adair Tissue Forceps, 9X10 Teeth, 6".....	24
Allis Tissue Forceps 4x5th 7 1/2".....	34
Allis Tissue Forceps, 3X4 Teeth, 6".....	25
Allis Tissue Forceps, 3X4Teeth, 6".....	25
Allis Tissue Forceps, 4X5 Teeth, 6".....	25
Allis Tissue Forceps, 5X6 Teeth, 6".....	25
Allis Tissue Forceps, 5X6 Teeth, 7 1/2".....	25
Allis-Willauer Tissue Forceps, 5X6 Teeth, 10".....	24
Alm Retractor 2 3/4" 4x4 Prongs.....	79
Alm Retractor 4" 4x4 Prongs.....	79
Apical Del 303 Elevator, 5 3/4".....	6
Autoclavable Front Surface Fiberglass Mirror, #4 and 5 White.....	16

B

Babcock Abdominal Forceps, 8".....	34
Babcock Abdominal Forceps, 9 1/2".....	34
Baby Allis Tissue Forceps 5 1/2" Delicate.....	25
Baby Allis Tissue Forceps 5" Extra Delicate.....	25
Baby Doyen Intestinal Forceps Curved 6 1/2".....	34
Baby Doyen Intestinal Forceps Straight 6 1/2".....	34
Baby Metzenbaum Scissors, Standard Curved 4 1/2".....	86
Baby Metzenbaum Scissors, Standard Straight, 4 1/2".....	86
Baby Metzenbaum Scissors, Supercut, Curved, 4 1/2".....	99
Baby Metzenbaum Scissors, Supercut, Straight, 4 1/2".....	99
Baby Olsen-Hegar Needle Holder, 4 1/2", TC.....	46
Baby Ribbon Retractor, Malleable .25", 7".....	79
Baby Ribbon Retractor, Malleable .5", 7".....	79
Baby Ribbon Retractor, Malleable .75", 7".....	79
Baby Ribbon Retractor, Malleable 1.0", 7".....	79
Baby Weitlaner Retractor 4" Blunt 2x3 Prongs.....	80
Baby Weitlaner Retractor 4" Sharp 2x3 Prongs.....	80
Backhaus Towel Clamp, 3 1/2".....	110
Backhaus Towel Clamp, 5 1/4".....	110
Backhaus Towel Clamps 4 1/2".....	110
Bailey Saw Guide 12".....	51

Balfour Abdominal Retractor 5 1/4" Spread, 2" x 1.65" Blade.....	80
Balfour Abdominal Retractor 7" Spread.....	80
Balfour Abdominal, solid side blades 2 3/4"x 7" Spread.....	80
Balfour Pediatric Retractor, 3 1/2" Spread.....	81
Bane Mastoid Rongeur, Curved, 7".....	30
Baron Suction Tube, Size 3 French, 7 1/2".....	32
Baron Suction Tube, Size 5 French, 7 1/2".....	32
Baron Suction Tube, Size 7 French, 7 1/2".....	32
Barraquer Eye Speculum (Colibri) 1 1/2".....	52
Barraquer Eye Speculum (Colibri) 1 1/4".....	52
Barraquer Eye Speculum Large Blades 1 3/4".....	52
Barraquer Needle Holder, Delicate Curved Jaw with lock 5 1/4".....	44
Barraquer Needle Holder, Smooth Jaws 5 1/4".....	44
Barraquer Needle Holder, Straight, Smooth Jaws with Lock, 5 1/2".....	44
Basic Periodontal Pack with sharpening Stone & Oil.....	72
Basic Rabbit Dental Pack.....	72
Baumgartner Needle Holder 5 1/2".....	49
Baumgartner Needle Holders, Serrated, 5 1/2", Tungsten Carbide.....	49
Baumgartner Needle Holders, Serrated, 5", Tungsten Carbide.....	49
Beasley Babcock Tissue Forceps, Cross Points, 4 3/4".....	25
Billeau Ear Loops, Delicate, 6 1/2", Large Loop.....	30
Billeau Ear Loops, Delicate, 6 1/2", medium Loop.....	30
Billeau Ear Loops, Delicate, 6 1/2", small Loop.....	30
Bishop Harmon Dressing Forceps Extra Delicate.....	25
Bishop Harmon Dressing Forceps Straight, 1 x 2 Teeth.....	25
Bishop Harmon Dressing Forceps, Straight Tips 3 3/8".....	25
Bone File, Double Ended, No. 10, 7".....	69
Bone File, Double Ended, No. 12, 7".....	69
Bone File, Double Ended, No. 33, 7".....	69
Bone File, Double Ended, No. 45, 7".....	70
Bone File, Double Ended, No. 64, 7".....	70
Bone Fragment Forceps 4" Regular.....	66
Bone Fragment Forceps 6" Large.....	66
Bone Holding Forceps.....	66
Bonn Suture Forceps, 0.12 For Microsurgery.....	109
Bonney Tissue Forceps, 1X2 Teeth, 7".....	25
Bonney Tissue Forceps, 2x3 Teeth, 7".....	26
Brown Tissue Forceps, double rows of 8x8 teeth, Size 6".....	26
Brown-Adson Side Grasping Fcps, 4 3/4", 7X7th.....	24
Brown-Adson Tissue Forceps, 7x7 side grasping.....	24
Buck Ear Curette, 5 3/4", Angled Sharp, Size 0.....	31
Buck Ear Curette, 5 3/4", Angled Sharp, Size 1.....	31
Buck Ear Curette, 5 3/4", Angled Sharp, Size 2.....	31
Buck Ear Curette, 5 3/4", Angled Sharp, Size 3.....	31
Buck Ear Curette, 5 3/4", Angled Sharp, Size 4.....	31
Buck Ear Curette, 5 3/4", Angled Sharp, Size 5.....	31
Buck Ear Curette, 5 1/2", Straight, Sharp, Size 0.....	31
Buck Ear Curette, 5 1/2", Straight, Sharp, Size 00.....	31
Buck Ear Curette, 5 1/2", Straight, Sharp, Size 1.....	31
Buck Ear Curette, 5 1/2", Straight, Sharp, Size 2.....	31

INDEX

C

Canine Mouth Gag Large Size 6 3/4"	16
Canine Mouth Gag Medium Size 5 3/4"	16
Canine Mouth Gag Small Size 4"	16
Canine/Feline Spay Pack	73
Cannulated Pin and Wire Cutter 7 1/2"	58
Carmalt (Splinter) Forceps, Curved, 4 3/4"	34
Carmalt (Splinter) Forceps, Straight, 4 3/4"	34
Cast Spreader Walton 9"	81
Castroviejo Eye Speculum 3 3/4"	52
Castroviejo Needle Holder, 5 1/2", Straight Without Catch	45
Castroviejo Needle Holder, 5 1/4", Curved Jaw With Catch	45
Castroviejo Needle Holder, Straight, Smooth with Lock 5 1/2"	45
Castroviejo Needle Holder, Straight, Smooth with Lock,, 5 1/2"	45
Castroviejo Needle Holders, Without Lock, Curved, 5 1/2"	45
Castroviejo Suturing Forceps, Curved, 0tying platform, 4 1/4"	34
Castroviejo Suturing Forceps, Straight, 4 1/4"	34
C-n-S- front side Pin and Wire Cutter TC Insert 7"	58
C-N-S- Pin and Wire Cutter TC Insert	58
Collier Needle Holder 5"	44
Cooley Vascular Tissue Forceps, tips 2mm wide, 6"	3
Cooley Vascular Tissue Forceps, tips 2mm wide, 8"	3
Crile Hemostatic Forceps Curved 5 1/2"	36
Crile Hemostatic Forceps Straight 5 1/2"	36
Crile-Rankin Hemostatic Forceps, Curved, 6 1/4"	36
Crile-Rankin Hemostatic Forceps, Straight, 6 1/4"	36
Crile-Wood Needle Holder, Tungsten Carbide, 10"	48
Crile-Wood Needle Holder, Tungsten Carbide, 12"	48
Crile-Wood Needle Holder, Tungsten Carbide, 7"	48
Crile-Wood Needle Holder, Tungsten Carbide, 8"	48
Crile-Wood Needle Holder, Tungsten Carbide, 9"	48
Crile-Wood Needle Holder, Standard 6"	48
Cruciate Needle Holder, Tungsten Carbide Jaws, 7"	48
CruciatePacks	74
Cruciate Repair Crimping Forceps	56
Curette Columbia 13-14 Fine TTDE, Double Ended	20
Curette Columbia 4L-4R TTDE, Double Ended	20
Curette Style H6/7	21

D

Dandy Nerve Hook 9"	56
Davis Stifle Retractor 7" With Speed Lock, Cross Action Tips	83
Dean Rongeur 3mm x 10mm Bite Curved, 5 3/4"	85
Debakey Adson Tissue Forceps, 4 3/4", 1.5 mm tips	3
Debakey Thoracic Tissue Forceps, 2.5mm wide Tips, 6"	3
Debakey Tissue Forceps, Atraumatic Jaws, 2.0mm, 6.25"	3
Debakey Tissue Forceps, Atraumatic Jaws, 2.0mm, 7.75"	3
Debakey Tissue Forceps, Atraumatic Jaws, 2.0mm, 9.5"	3
Debakey Tissue Forceps, Atraumatic Jaws, 3.5mm, 6.25"	3
Debakey Tissue Forceps, Atraumatic Jaws, 3.5mm, 7.75"	3
Debakey Tissue Forceps, Atraumatic Jaws, 3.5mm, 9 1/2"	3
Debakey Vascular Clamp for Aortic Aneurism, slightly curved	4
Debakey Vascular Clamp for Aortic Aneurism, 12 cm, Size 12 3/4"	4
Debakey Vascular Clamp for Aortic Aneurism, Size 10"	4
Debakey Vascular Clamp for Aortic Aneurism, slightly 10 1/2"	4
Debakey Vascular Tissue Forceps, 1.5mm wide Tips, 6"	4
Debakey Vascular Tissue Forceps, 1.5mm wide Tips, 8"	4
Debakey Vascular Tissue Forceps, 1.5mm wide Tips, 9 1/2"	4
Deluxe Mirror Handle Cone Socket	18

Dental Explorer 2D	11
Dental Explorer and Graduated Probe, D/E style PE1-23	11
Dental Explorer, 17	12
Dental Explorer, Style 7	12
Dental Explorer, style 3A	12
Dental Extracting Forceps Universal, Witzel, DEF116	8
Dental Extracting Forceps Universal, Witzel, DEF120	8
Dental Extracting Forceps, 1st and 2nd Molar, Left, 18L	8
Dental Extracting Forceps, A, Pedro Upper Molar, Universal, Mini	8
Dental Extracting Forceps, B, Pedro Lower Root, Universal, Mini	9
Dental Extracting Forceps, E, Pedro Upper Front, Mini	9
Dental Extracting Forceps, F, Pedro Upper Root, Universal, Mini	9
Dental Extracting Forceps, Lower Incisors, Roots, Universal, 151	9
Dental Extracting Forceps, Upper and Lower Universal, 101	9
Dental Extracting Forceps, Upper and Lower Fragments and Roots	9
Dental Extracting Forceps, Upper and Lower 6	10
Dental Extracting Forceps, Upper Anteriors, Split Beaks	10
Dental Extracting Forceps, Upper Bicuspid, Incisors and Roots, 286	10
Dental Extracting Forceps, Upper Incisors, Cuspids, Universal, 150	10
Dental Extracting Forceps, Upper Incisors, Henahan, 1HEN	10
Dental Extracting Forceps, C, Pedro Lower Molars, Universal, Mini	10
Dental Laryngeal Mirror Size 0, 12mm	17
Dental Laryngeal Mirror Size 1, 14mm	17
Dental Laryngeal Mirror Size 2, 16mm	17
Dental Laryngeal Mirror Size 3, 18mm	17
Dental Laryngeal Mirror Size 4, 20mm	17
Dental Laryngeal Mirror Size 5, 22mm	17
Dental Laryngeal Mirror Size 6, 26mm	17
Dental Standard Extracting Forceps #62	11
Depth Gauge, Mini Screw	42
Depth Gauge, Regular	42
Derf Needle Holder 4 3/4" Serrated	48
Derf Needle Holder, Serrated, 4 3/4", Tungsten Carbide	48
Desmarres Chalazion Forceps, 16mm, 3 1/2"	53
Desmarres Chalazion Forceps, 20mm Diameter, 3 1/2"	53
Desmarres Chalazion Forceps, 25mm Diameter, 3 1/2"	53
Desmarres Chalazion Forceps, 30mm Diameter, 3 1/2"	53
Diamond Pin and Wire cutter 6 1/2"	58
Disposable Scalpel, Stainless Steel Blade, Plastic Handle, Size 12	101
Disposable Scalpels, Stainless Steel Blade, Plastic Handle, Size 21	101
Double Action Pin Cutter 15"	58
Doyen Abdominal Scissors, 7" curved	87
Doyen Abdominal Scissors, 7" straight	87
Doyen Intestinal Forceps Curved 9"	34
Doyen Intestinal Forceps Straight 9"	34
Duckbilled Mini-Rongeur 5"	59

E

Echlin Rongeur (Duckbill) 9" Angular 2x15mm Bite	59
Echlin Rongeur (Duckbill) 9" Angular 3x15mm Bite	59
Echlin Rongeur (Duckbill) 9" Angular 4x15mm Bite	59
Economy Utility Scissors, Serrated, 5 1/2"	62
Economy Utility Scissors, Serrated, 7 1/2"	62
Elevator, Periosteal, Molt, DEL M9	12
Emergency Room Shears, 8 1/2" serrated edge	87
Engel Cast Cutter 6"	68

Eppendorfer-Krause Rotating Shaft Biopsy Forceps, Size 9",.....	68
Excavator Style #33L.....	12
Excavator Style #38/39.....	12
Excavator Style #61/62.....	13
Excision Arthroplasty Rasp 170mm.....	70
Eye Dressing Forceps Straight, Serrated Tips, 4".....	26
Eye Dressing Forceps, 4" Half-Curved Tips, Heavy Pattern.....	26
Eye Dressing Forceps, 4" Heavy Pattern.....	26
Eye Dressing Forceps, 4" Serrated, Straight Tips.....	26
Eye Dressing Forceps, Full Curved, Serrated Tips, 4".....	26
Eye Dressing Forceps, Half Curved, Serrated Tips, 4".....	26
Eye Suture Scissors, Curved Pointed Blades 3 3/4".....	53

F

Feline Bandage Scissors, 7".....	92
Feline Mouth Gag Light Weight 3".....	16
Feline Petite Mouth Gag light Weight 2 1/4".....	16
Ferguson Angiotribe Forceps Curved 6 1/2".....	36
Ferguson Angiotribe Forceps Curved 7 1/2".....	36
Ferguson Angiotribe Forceps Straight 6 1/2".....	36
Ferguson Angiotribe Forceps Straight 7 1/2".....	36
Ferguson Gall Stone Scoop Double Ended, Small, 9 1/2".....	56
Ferguson Gall Stone Scoop Double Ended, Large, 9 1/2".....	56
Ferguson Gall Stone Scoop Double Ended, Medium, 9 1/2".....	56
Ferguson-Frazier Suction Tubes, 10 French.....	32
Ferguson-Frazier Suction Tubes, 11 French.....	32
Ferguson-Frazier Suction Tubes, 12 French.....	32
Ferguson-Frazier Suction Tubes, 14 French.....	32
Ferguson-Frazier Suction Tubes, 6 French.....	32
Ferguson-Frazier Suction Tubes, 7 French.....	32
Ferguson-Frazier Suction Tubes, 8 French.....	32
Ferguson-Frazier Suction Tubes, 9 French.....	32
Ferris Smith Rongeur 7" 4mmx10mm Up Angle.....	85
Ferris Smith Rongeur 7" 6mmx10mm Down Angle.....	85
Ferris Smith Rongeur 7" 6mmx10mm Straight.....	85
Ferris Smith Rongeur 7" 6mmx10mm Up Angle.....	85
Ferris Smith Rongeur 7" 6mmx12mm Straight.....	85
Ferris Smith Tissue Forceps, 2x3 Teeth, 6 3/4".....	26
Finger Ring Cutter Blade.....	43
Finger Ring Cutter With Blade.....	43
Finochietto Rib Spreader, Original Model, Standard Size,12".....	81
Finochietto Rib Spreader, Original Model, Standard Size.....	81
Finochietto Rib Spreader, Original Model, Standard Size.....	81
Finochietto Thoracic Forceps and Ligature Carrier 9 1/2".....	110
Finochietto Thoracic Forceps, slightly curved jaws, 9".....	110
Foerster Sponge Forceps, Serrated Jaws Curved, 7".....	111
Foerster Sponge Forceps, Serrated Jaws Curved, 9 1/2".....	111
Foerster Sponge Forceps, Serrated Jaws Straight, 7".....	111
Foerster Sponge Forceps, Serrated Jaws Straight, 9 1/2".....	111
Fomon Rasp, Coarse Teeth 8 1/4".....	71
Fomon Rasp, Fine Teeth 8 1/4".....	71
Fomon Rasp, Sided Teeth 8 1/4".....	71
For measuring and marking, 3 1/4", 8.5 cm.....	42
Freer Elevators, Double Ended With Blunt/sharp Blades, 7", 5mm.....	57
Friedman Dental Rongeur 5 1/2", Curved & Delicate.....	13
Fulton Laminectomy Rongeur, slightly curved jaws, 7 x 18 mm.....	50
Fulton Laminectomy Rongeur, Straight jaws, 7 x 18 mm, Size 9 1/2".....	50

G

Gelpi Retractor 3 1/2".....	82
Gelpi Retractor 4 1/2".....	82
Gelpi Retractor 4 1/2" Right Angled.....	82
Gelpi Retractor 5 1/4".....	82
Gelpi Retractor 7".....	82
Gelpi Retractor Right Angled 5 1/2".....	82
Gelpi Retractor With Grip Lock 6 3/4".....	82
Gemini-Mixter, Delicate, Full Curved Jaws, 5 1/2".....	35
Gemini-Mixter, Delicate, Full Curved Jaws, 7".....	35
Gemini-Mixter, Delicate, Full Curved Jaws, 8".....	35

Gemini-Mixter, Delicate, Full Curved Jaws, 9".....	35
German Advanced Eye Pack.....	74
German Starter Eye Pack.....	75
Gerzog Mallet 7 1/2" 100Z.....	63
Gerzog Mallet 7" 16oz.....	63
Gerzog Mallet, 7 1/2" 7oz.....	63
Gigli Saw 12", Standard twisted wire type.....	51
Gigli Saw 20", Standard twisted wire type.....	51
Gigli Saw 30", Standard twisted wire type.....	51
Gigli Saw Handle, T-Shape turnable, Standard 2 1/2".....	51
Gigli-Strully Saw Handle, T-Shape,Rigid with snap lock, Standard.....	51
Gillies Hook, Small 8".....	67
Goldman Fox Scissors, Curved 5", SUPERCUT.....	98
Goldman Fox, Curved 5", Tungsten Carbide.....	97
Goldstein Eye Retractor, 3x3 pointed prongs, 5mm Deep 1 1/8".....	82
Goniometer Polk Finger 6" Graduated cm/inch.....	42
Gossett Abdominal Retractor, 5.5".....	82
Gracey Curettes 11/12, Double Ended.....	20
Gracey Curettes 11/14.....	21
Gracey Curettes 12/13.....	21
Gracey Curettes 13/14, Double Ended.....	20
Gracey Curettes 15/16.....	21
Gracey Curettes 17/18.....	21
Gracey Curettes 3/4, Double Ended.....	21
Gracey Curettes 5/6, Double Ended.....	21
Gracey Curettes 9/10, Double Ended.....	20
Gracey Curettes G 1/2, Double Ended.....	21
Gradle Scissors Curved 3 3/4".....	91
Gradle Scissors, Curved 3 3/4", SUPERCUT.....	99
Graduated Probe, Style "C".....	79
Graefe Eye Speculum 3 1/2".....	52
Graefe Fixation Forceps 4 3/8", Without Catch.....	54
Graefe Fixation Forceps 4 3/8" Non magnetic without catch.....	54
Graft Curved Passer, 2.0cm.....	60
Graft Curved Passer, 3cm.....	60
Graft Curved Passer, 4.5cm.....	60
Graft Curved Passer, Extra Large.....	60
Graft Curved Passer, xx-Large.....	60
Grooved Director 4 1/2".....	79
Grooved Director 5 1/2".....	79
Grooved Director 5".....	79
Grooved Director 6".....	79
Gruenwald Nasal Punch 4 1/2" Shaft, 2 x 10mm Bite.....	43
Gruenwald Nasal Punch 4 1/2" Shaft, 2.5 x 12mm Bite.....	43
Gruenwald Nasal Punch, 4 1/2" Shaft, 3 X 12mm Bite.....	43

H

Halsey Needle Holder, Serrated Jaws, 5",.....	47
Halsey Needle Holder, Smooth Jaws, 5",.....	47
Halsey Needle Holder, Tungsten Carbide, Serrated Jaw, 5".....	47
Halsey Needle Holder, Tungsten Carbide, Smooth Jaw, 5".....	47
Halstead Mosquito Forceps Curved 5".....	37
Halstead Mosquito Forceps Straight 5".....	37
Halstead Mosquito Forceps, Curved 1x2 Teeth, 5".....	37
Halstead Mosquito Forceps, extra delicate, Curved, Size 5".....	37
Halstead Mosquito Forceps, extra delicate, Straight, Size 5".....	37
Halstead Mosquito Forceps, Straight 1x2 Teeth, 5".....	37
Hartman Alligator Forceps.....	32
Hartman Alligator Forceps.....	32
Hartman Alligator Forceps.....	32
Hartman Alligator Forceps 1 x 2 Teeth.....	32
Hartman Alligator Forceps Round Cup Jaws, 2 1/2".....	32
Hartman Mosquito Forceps, Curved Standard Pattern, 3 1/2".....	36
Hartman Mosquito Forceps, Straight Standard Pattern, 3 1/2".....	36
Hartman Rongeur, Curved 4x12mm bite, Size 5 3/4".....	33
Hartman-Noyes Ear Forceps, Alligator Type, Serr, 3" Shaft.....	44

Heaney Needle Holder Curved, 10".....	47
Heaney Needle Holder Curved, 8 1/4".....	47
Heaney Needle Holder, Tungsten Carbide, Curved, 10".....	47
Heavy Duty Cruciate Needle Driver, Tungsten Carbide.....	106
Heidbrink Root Tip Pick, Del H1, Delicate, Straight, 5 1/4".....	5
Heidbrink Root Tip Pick, Del H2-3, Delicate, Double Ended, 7 3/4".....	5
Heidbrink Root Tip Pick, Del H3, Delicate, Left, 5 1/4".....	5
Heidbrink Root Tip Pick, Del H3, Delicate, Right, 5 1/4".....	5
Hi-Level Bandage Scissors, Angled 5 1/2".....	92
Hirschfeld File, 3-7.....	13
Hirschfeld File, 5-11.....	13
Hirschfeld File, 9-10.....	13
Hoff Non Perforated Towel Clamp 5 1/4".....	111
Hohmann Retractor 10mm wide, 9 1/4"/ 23 Cm.....	57
Hohmann Retractor, 12 mm Width, 8".....	57
Hohmann Retractor, 18 mm Width, 9".....	57
Hohmann Retractor, 22mm Wide Blade.....	57
Hohmann Retractor, 43mm Wide Blade.....	57
Hohmann Retractor, 70mm Wide Blade.....	57
Hoke Osteotomes, 5 1/2",Straight, 1/2".....	61
Hoke Osteotomes, 5 1/2",Straight, 1/4".....	61
Hoke Osteotomes, 5 1/2",Straight, 1/8".....	61
Hoke Osteotomes, 5 1/2",Straight, 3/16".....	61
Hoke Osteotomes, 5 1/2",Straight, 3/8".....	61
Hoke Osteotomes, 5 1/2",Straight, 5/16".....	61
Holzheimer Retractor 4" 4x4 Prongs Blunt.....	82
Holzheimer Retractor 4" 4x4 Prongs Sharp.....	82
Hudson Brace, Large.....	83
Hudson Brace, Small.....	83

I	
Inge Retractor, 11".....	83
Inge Retractor, 6 1/2".....	83
Iris Scissors Curved 3 1/2".....	93
Iris Scissors Curved 4 1/2" With Sharp Tips.....	93
Iris Scissors Str 4 1/2" With Sharp Tips.....	93
Iris Scissors Straight 3 1/2".....	93
Iris Scissors, 3 1/2" Curved, With Sharp Tips.....	93
Iris Scissors, 3 1/2" Straight, With Sharp Tips.....	93
Iris Scissors, Curved 4" Sharp Points.....	93
Iris Scissors, Curved Supercut, 4 1/2".....	99
Iris Scissors, Curved Tungsten Carbide, 4 1/2".....	89
Iris Scissors, Straight 4" Sharp Points.....	93
Iris Scissors, Straight Supercut, 4 1/2".....	99
Iris Scissors, Straight Tungsten Carbide, 4 1/2".....	89
Iris Scissors, Tungsten Carbide Inserts, Curved, 4 1/2"/ 11.5 cm.....	98
Iris Scissors, Tungsten Carbide Inserts, Straight, 4 1/2"/ 11.5 cm.....	98
Iris Tissue Forceps 1/2 Curved.....	27
Iris Tissue Forceps 4" 1x2 teeth.....	27
Iris Tissue Forceps 4", 1x2th, Full Curved.....	27

J	
Jacobson Micro Mosquito Forceps, Curved, Size 5".....	36
Jacobson Micro Mosquito Forceps, Curved, Size 7".....	36
Jacobson Micro Mosquito Forceps, Straight Size 7".....	36
Jacobson Micro Mosquito Forceps, Straight, Size 5".....	36
Jacquette Scaler, 20/33.....	18
Jacquette Scaler, 33/H5.....	18
Jacquette Scaler, Double Ended, 1Y/1Y.....	18
Jacquette Scaler, Double Ended, 2/3.....	18
Jacquette Scaler, Double Ended, 2S/3S.....	19
Jacquette Scaler, Double Ended, 2Y/3Y.....	19
Jacquette Scaler, Single Ended, U-15.....	19
Jansen Bayonet Forceps, Serrated, 7 1/2".....	54
Jeweler's Forceps # 7 Swiss Style, Extra Fine Tips, Curved, 4 1/2".....	53

Jeweler's Forceps, # 5 Swiss Style, Fine Points, Angled, 4 1/2".....	53
Jeweler's Tweezers, #5 Superfine Point, 4 3/4".....	54
Jones Towel Clamp, 3".....	111
Jones Towel Clamp, Light Weight 2 1/4".....	111
Joseph Hook Double Prong, 5mm Wide, 6".....	67
Joseph Hook, Double Prong, 2mm Wide, 6".....	67
Joseph Hook, Sharp Single Prong, 6".....	67

K	
Keith Abdominal Surgical Needle, Straight Triangular Point.....	106
Kelly Hemostatic Forceps Curved 5 1/2".....	37
Kelly Hemostatic Forceps Straight 5 1/2".....	37
Kern Bone Holding Forceps 9 1/2" With Ratchet.....	65
Kern Bone Holding Forceps 9 1/2" Without Ratchet.....	65
Kerrison Rongeur 7" 1mm Down-Bite 40 Degree.....	85
Kerrison Rongeur 7" 1mm Up-Bite 90 Degree.....	85
Kerrison Rongeur 7" 2mm Up-Bite 90 Degree.....	85
Kerrison Rongeur 7" 3mm Up-Bite Thin Foot Plate 40 Degree.....	85
Key Elevator, 7 1/2", Squared .25".....	70
Key Elevator, 7 1/2", Squared .5".....	70
Key Elevator, 8 1/4", Squared 1.0".....	70
Key Elevator, 8", Squared .75".....	70
Keyes Cutaneous Punch, 2 mm Tip, 4" (10cm).....	61
Keyes Cutaneous Punch, 3 mm Tip, 4" (10cm).....	61
Keyes Cutaneous Punch, 4 mm Tip, 4" (10cm).....	61
Keyes Cutaneous Punch, 6 mm Tip, 4" (10cm).....	61
Keyes Cutaneous Punch, 8 mm Tip, 4" (10cm).....	61
Killian Canine Speculum 2".....	101
Killian Canine Speculum 3 1/2".....	101
Killian Canine Speculum 3".....	101
Kirschner Wires, 12" flat end 1.6mm.....	68
Kirschner Wires/ w/flat end 0.9MM 12".....	68
Kirschner Wires/ w/flat end 1.1mm 12".....	68
Knife Handle No. 3, Fits blades 10-15.....	40
Knife Handle No. 3, Graduated in Millimeters.....	40
Knife Handle No. 3L, Long handle for Deep Surgery.....	40
Knife Handle No. 4, Fits Blades, 20- 25.....	40
Knife Handle No. 4, Graduated in Millimeters.....	41
Knife Handle No. 4L, Fits Blades 2025, Long Handle for Deep Surgery.....	41
Knife Handle No. 5, Fits Blades 10-15, Extra Fine, Plastic.....	41
Knife Handle No. 6, Fits Blades 20-25, Extra Fine, Plastic.....	41
Knife Handle No.7.....	41
Knife Handle, Round, Fitting blades 10-15.....	41
Knowles Bandage Scissors, Straight 5 1/2".....	91
K-wire Small Pin Punch.....	61
K-wire sutter, TC 2.2MM.....	59
K-wire sutter, TC 2.5MM.....	59

L	
Lahey Retractor 1 Sharp Prong, 4 3/4".....	84
Lahey Retractor 2 Sharp Prongs, 4 3/4".....	84
Lahey Retractor 3 Sharp Prongs, 4 3/4".....	84
Lahey Vulsellum Forceps, 3X3 Teeth, 6 1/4".....	27
Lambert-Lowman Bone Clamp, Bone Clamp 1" Wide.....	64
Lancaster Eye Speculum 2 3/4".....	52
Lane Bone Forceps 13" Standard With Ratchet.....	65
Lane Bone Forceps 13" Standard Without Ratchet.....	65
Lane Bone Holding Forceps, 17" Plain".....	65
Lane Bone Holding Forceps, 17" With Ratchet.....	65
Leksell Rongeur 9" 4x16mm Bite Angled.....	86
Leksell Rongeur 9" 7x16mm Bite Angled.....	86
Lempert Rongeur 2.5mm x 10mm Bite Curved 6 1/2".....	86
Lempert Rongeur 2.5mm x 10mm Bite Straight 6 1/2".....	86
Lewin Bone Holding Forceps 7".....	65
Ligament Meniscus Clamp.....	59
Lister Bandage Scissors 3 1/2".....	92
Lister Bandage Scissors 4 1/2".....	92

Lister Bandage Scissors 5 1/2".....	92
Lister Bandage Scissors 7 1/4".....	92
Lister Bandage Scissors 8" 20.3cm.....	92
Lister Bandage Scissors 8" With One Large Ring.	92
Liston Bone Cutting Forceps, Angled, 5 1/2".....	64
Liston Bone Cutting Forceps, Angled, 7 1/2".....	64
Liston Bone Cutting Forceps, Angled, 8 3/4".....	64
Liston Bone Cutting Forceps, Straight, 5 1/2".....	64
Liston Bone Cutting Forceps, Straight, 7 1/2".....	64
Liston Bone Cutting Forceps, Straight, 8 3/4".....	64
Littauer Stitch Scissors, 4 1/2" straight.....	100
Littauer Stitch Scissors, 5 1/2" Straight.....	100
Loopuyt Surgical Needle, Cutting Edge.....	107
Lorna Edna Towel Clamp, Non-Perforating, 5 1/4".....	111
Lorna Non-Perforated Towel Clamp 3 1/2".....	111
Lovelace Lung Grasping Forceps, 7 1/4".....	62
Lovelace Lung Grasping Forceps, Straight serrated jaws 1" wide, 8".....	62
Lucae Forceps, Serrated, 5 1/2".....	62
Lucae Mallet 7 3/4" 7OZ Convex/Flat Head.....	63
Lucae Mallet 8" 8OZ Convex/Flat.....	63
Lucas Bone Curette, No.87.....	19
Lucas Bone Curette, No. 85.....	19
Lucas Bone Curette, No. 86.....	20
Luer Rongeur 8x10mm Bite Curved 7".....	50
Luer Rongeur 8x10mm Bite Straight 7".....	50
Luer Rongeurs, Curved, 7".....	50
Luer Rongeurs, Straight, 7".....	50
Luxating Elevator, Curved Tip 2mm, 5 3/4".....	7
Luxating Elevator, Curved Tip 3mm, 5 3/4".....	7
Luxating Elevator, Curved Tip 4mm, 5 3/4".....	7
Luxating Elevator, Curved Tip 5mm, 5 3/4".....	7
Luxating Elevator, Straight Tip 2mm, 5 3/4".....	7
Luxating Elevator, Straight Tip 3mm, 5 3/4".....	7
Luxating Elevator, Straight Tip 4mm, 5 3/4".....	7
Luxating Elevator, Straight Tip 5mm, 5 3/4".....	7

M

Mallet Solid Stainless 11" 16oz.....	63
Mallet, lightweight, 7.5 oz, Stainless head, Size 7 1/2".....	63
Mallet, lightweight, 9 oz, Stainless head, Size 7 1/2".....	63
Mathieu Needle Holder, Tungsten Carbide, 5 1/2".....	49
Mathieu Needle Holder, Tungsten Carbide, 6 1/2".....	49
Mayo Common Duct Scoop Large, Malleable, 10 1/2".....	71
Mayo Common Duct Scoop Medium, Malleable, 10 1/2".....	71
Mayo Common Duct Scoop Small, Malleable, 10 1/2".....	71
Mayo Dissecting Scissors 5 1/2" Curved Tungsten Carbide.....	97
Mayo Dissecting Scissors 5 1/2" Straight Tungsten Carbide.....	97
Mayo Dissecting Scissors 6 3/4" Curved Tungsten Carbide.....	97
Mayo Dissecting Scissors 6 3/4" Straight Tungsten Carbide.....	97
Mayo Dissecting Scissors 7" Curved SUPERCUT.....	98
Mayo Dissecting Scissors 9" Straight SUPERCUT.....	98
Mayo Dissecting Scissors Curved 5 1/2".....	87
Mayo Dissecting Scissors Curved 5 1/2" SUPERCUT.....	98
Mayo Dissecting Scissors Curved 6 3/4" SUPERCUT.....	98
Mayo Dissecting Scissors Curved 9".....	87
Mayo Dissecting Scissors Straight 5 1/2".....	87
Mayo Dissecting Scissors Straight 6 3/4".....	87
Mayo Dissecting Scissors Straight, 5 1/2" SUPERCUT.....	98
Mayo Dissecting Scissors Straight, 6 3/4" SUPERCUT.....	98
Mayo Dissecting Scissors, 9" straight.....	87
Mayo Dissecting Scissors, Curved, 6 3/4".....	87
Mayo Dissecting Scissors, Tungsten Carbide Insert, Curved, 9".....	97
Mayo Dissecting Scissors, Tungsten Carbide Insert, Straight, 9".....	97
Mayo Gall Stone Scoop, Double Ended, 11 1/2"/28cm.....	71
Mayo Hegar Needle Holder 5 1/4".....	45
Mayo Hegar Needle Holder 6".....	45
Mayo Hegar Needle Holder 7".....	45
Mayo Hegar Needle Holder 8".....	45

Mayo Hegar Needle Holder, Serrated, 5 1/4", Tungsten.....	45
Mayo Hegar Needle Holder, Tungsten Carbide, 12".....	45
Mayo Hegar Needle Holders, Serrated, 10 1/2", Tungsten.....	45
Mayo Hegar Needle Holders, Serrated, 6", Tungsten.....	45
Mayo Hegar Needle Holders, Serrated, 7", Tungsten.....	45
Mayo Hegar Needle Holders, Serrated, 8", Tungsten.....	45
Mayo Hegar Needle Holders, Serrated, 9", Tungsten.....	45
Mayo Stille Scissors, Tungsten Insert, Curved, 6 3/4".....	97
Mayo Stille Scissors, Tungsten ,Straight, 6 3/4".....	97
McCalls Curette, Style 11/14.....	22
McCalls Curette, Style 17/18.....	22
Mead Mallet 7 1/2".....	63
Meeker Kantrowitz Forceps, Full Curved Jaws, 7 3/4".....	66
Meltzer Adenoids Nasal Punch 5" Shaft, Size 2.....	43
Meniscus Knife 7 1/2".....	57
Metzenbaum Curved 4 1/2" Supercut.....	99
Metzenbaum Dissecting Scissors 8" Delicate.....	93
Metzenbaum Dissecting Scissors Curved 5".....	94
Metzenbaum Dissecting Scissors Curved 7".....	94
Metzenbaum Dissecting Scissors Curved 5 3/4" Supercut.....	99
Metzenbaum Dissecting Scissors Curved 7" Supercut.....	99
Metzenbaum Dissecting Scissors Curved 9"(nelson).....	99
Metzenbaum Dissecting Scissors Straight 7" SUPERCUT.....	99
Metzenbaum Dissecting Scissors Straight 9" SUPERCUT.....	99
Metzenbaum Dissecting Scissors Str 5" Delicate.....	93
Metzenbaum Dissecting Scissors Str 6" Delicate.....	93
Metzenbaum Dissecting Scissors Straight 5".....	94
Metzenbaum Dissecting Scissors, Delicate, 7" straight.....	93
Metzenbaum Dissecting, Delicate, 9" straight.....	93
Metzenbaum Scissors (Lahey), Curved, 5.75",TC.....	95
Metzenbaum Scissors (Lahey), Curved , 5.75",TC.....	95
Metzenbaum Scissors (Lahey), Curved Standard, 5.75",TC.....	95
Metzenbaum Scissors (Lahey), Curved, 5.75", Standard.....	93
Metzenbaum Scissors (Lahey), Pedifine Curved, 4.5",.....	93
Metzenbaum Scissors (Lahey), Straight, 5.75", TC.....	95
Metzenbaum Scissors (Lahey), Straight Standard, 5.75",TC.....	95
Metzenbaum Scissors (Lahey), Straight, 5.75", Standard.....	93
Metzenbaum Scissors (Lahey),Pedifine Straight, 4 1/2".....	93
Metzenbaum Scissors (Lahey),Straight , 5.75",TC.....	95
Metzenbaum Scissors (Nelson), Curved Delicate, 7",TC.....	95
Metzenbaum Scissors (Nelson), Curved Delicate, 9",TC.....	95
Metzenbaum Scissors (Nelson), Curved, 10", Standard.....	94
Metzenbaum Scissors (Nelson), Curved, 11", Standard.....	94
Metzenbaum Scissors (Nelson), Curved, 7", Standard.....	94
Metzenbaum Scissors (Nelson), Curved, 7",TC.....	95
Metzenbaum Scissors (Nelson), Curved, 8", Standard.....	94
Metzenbaum Scissors (Nelson), Curved, 9", Standard.....	94
Metzenbaum Scissors (Nelson), Straight Delicate, 7",TC.....	94
Metzenbaum Scissors (Nelson), Straight Delicate, 9",TC.....	95
Metzenbaum Scissors (Nelson), Straight, 9", Standard.....	94
Metzenbaum Scissors (Nelson), Straight, 9", TC.....	95
Metzenbaum Scissors (Nelson), Straight, 10", Standard.....	94
Metzenbaum Scissors (Nelson), Straight, 11", Standard.....	94
Metzenbaum Scissors (Nelson), Straight, 7",TC.....	95
Metzenbaum Scissors (Nelson), Straight, 8", Standard.....	94
Metzenbaum Scissors 5 1/2" Curved Supercut.....	99
Metzenbaum Scissors 5 1/2" Straight, Standard.....	94
Metzenbaum Scissors 5 1/2" Straight, Supercut.....	99
Metzenbaum Scissors 5" Curved, Supercut.....	99
Metzenbaum Scissors 7" Curved,Supercut.....	99
Metzenbaum Scissors Curved 8".....	94
Metzenbaum Scissors Straight 7".....	94
Metzenbaum Scissors TC Insert,, curved, 5 1/2"/ 14.5 cm.....	96
Metzenbaum Scissors TC, Standard, Curved, 7"/ 17.5 cm.....	96
Metzenbaum Scissors TC Insert, , Curved, 8"/ 20 cm.....	96
Metzenbaum Scissors, Supercut, Straight, 5 1/2".....	99
Metzenbaum Scissors, Supercut, Straight, 7".....	99

Metzenbaum Scissors, TC, Delicate,Curved, 5 1/2".....	96
Metzenbaum Scissors, TC Insert, Delicate,Curved, 7".....	96
Metzenbaum Scissors, TC Insert, Delicate,Curved, 9".....	96
Metzenbaum Scissors, TC Insert, Delicate,Straight, 5 1/2".....	96
Metzenbaum Scissors, TC Insert, Delicate,Straight, 7" 17.5 cm.....	96
Metzenbaum Scissors, TC Insert, Delicate,Straight, 9"/ 22.5m.....	96
Metzenbaum Scissors, TC Insert, Standard, Curved, 11"/ 27.5 c.....	96
Metzenbaum Scissors, TC Insert, Standard, Straight, 7"/ 17.5 cm.....	96
Metzenbaum Scissors, TC Insert, Standard, Straight, 8"/ 20 cm.....	96
Metzenbaum Scissors, TC Insert, Standard, Straight, 9"/ 22.5 cm.....	96
Metzenbaum Straight 4 1/2" Supercut.....	99
Metzenbum Scissors Curved 9".....	94
Metzenbum Scissors Straight 14 1/2".....	94
Metzenbum Scissors Straight 9".....	94
Meyerding Retractor, 52mmX16mm Blade, Small, 10".....	83
Meyerding Retractor, 75mmX25mm Blade, Medium, 10".....	83
Meyerding Retractor, 89mm X 50mm Blade, Large, 10".....	83
Michele Trephine, 6 1/4" graduated.....	51
Michele Trephine, 6 1/4" shaft.....	51
Michele Trephine, Marker	51
Micro Friedman Ronguers, Curved Jaws, angled 15 Degrees, 5 1/2"....	86
Micro Friedman Ronguers, Curved Jaws, 90 Degrees, 5 1/2".....	86
Micro Mosquito Forceps, Curved, Very Delicate Pattern, 4 3/4".....	66
Micro Mosquito Forceps, Straight, Very Delicate Pattern, 4 3/4".....	66
Micro Surgery Needle Holder 5 1/4", Curved Jaws.....	47
Micro Surgery Needle Holder 7 1/8", Curved Jaws.....	47
Micro Surgery Needle Holder 7 1/8", Straight Jaws.....	47
Micro Surgery Needle Holder, 5 1/4.....	47
Micro Surgery Needle Holder, 7 1/8", Curved Jaws With Lock.....	47
Micro Surgery Needle Holder, 7 1/8", Straight Jaws With Lock.....	47
Microsurgical (Beaver) Blade Handle 4" in Length.....	41
Microsurgical (Beaver) Blade Handle 5" in Length.....	41
Mini Lambotte Osteotome 5" Straight 10mm.....	60
Mini Lambotte Osteotome 5" Straight 2mm.....	60
Mini Lambotte Osteotome 5" Straight 4mm.....	60
Mini Lambotte Osteotome 5" Straight 6mm.....	60
Mini Lambotte Osteotome 5" Straight 8mm.....	60
Mini-Hohman Retractor 6 1/4".....	57
Mini-Hohman Retractor 6 1/4".....	57
Mirror Handle Cone Socket/Mirror #4.....	16
Modified Gigli Bone Saw Wire, Loop Grip.....	51
Modified Gigli Bone Saw Wire, Turnable.....	51
Modified Stifle Retractor 18cm.....	83
Morse Scaler 0-00.....	19

N

Neoprene Cord 32" For Tourniquet 6 1/4".....	42
Northbent Stitch Scissors 3 1/2".....	100
Northbent Stitch Scissors, Curved Sideways, 4 1/2".....	100
Noyes Alligator Forceps, Serrated Shaft, 5 1/2".....	44
Noyes Alligator Forceps, Serrated Shaft, 6 1/2".....	44

O

Ochsenbein Chisel #1.....	13
Ochsenbein Chisel #2.....	13
Ochsenbein Chisel 4.....	13
Octagonal Mirror Handle, Cone socket.....	18
Olsen-Hegar Combined Ndl Hldr and Scrs, Delicate, 4 3/4", TC.....	46
Olsen-Hegar Combined Needle Holder & Scissors 5 1/2".....	46
Olsen-Hegar Combined Needle Holder & Scissors 6 1/2".....	46
Olsen-Hegar Combined Needle Holder & Scissors 7 1/4".....	46
Olsen-Hegar Combined Needle Holder and Scissors, 6 1/4",TC.....	46
Olsen-Hegar Needle Holder, European Pattern, 6 1/2".....	46
Olsen-Hegar Needle Holder, Tungsten Carbide, 5 1/2".....	46
Olsen-Hegar Needle Holder, Tungsten Carbide, 7 1/2".....	46

Operating Scissors Standard pattern straight, Sharp/Sharp, 4 1/2".....	88
Operating Scissors Standard pattern, curved, Sharp/ Blunt, 6".....	88
Operating Scissors Standard pattern, curved, Sharp/Blunt, 4 1/2".....	88
Operating Scissors Standard pattern, curved, Sharp/Blunt, 5 1/2".....	88
Operating Scissors Standard pattern, curved, Sharp/Blunt, 5".....	88
Operating Scissors Standard pattern, curved, Sharp/Blunt, 6 1/2".....	88
Operating Scissors Standard pattern, curved, Sharp/Blunt, 7 1/2".....	88
Operating Scissors Standard pattern, curved, Sharp/Sharp, 4 1/2".....	89
Operating Scissors Standard pattern, curved, Sharp/Sharp, 5 1/2".....	89
Operating Scissors Standard pattern, curved, Sharp/Sharp, 5".....	89
Operating Scissors Standard pattern, curved, Sharp/Sharp, 6 1/ 2".....	89
Operating Scissors Standard pattern, curved, Sharp/Sharp, 6".....	89
Operating Scissors Standard Pattern, sharp/sharp, Curved 5 1/2", SC....	91
Operating Scissors Standard Pattern, sharp/sharp, Straight 5 1/2", SC..	91
Operating Scissors Standard pattern, straight, 5" Sharp/Sharp.....	88
Operating Scissors Standard pattern, straight, 6".....	89
Operating Scissors Standard pattern, straight, Blunt/Blunt, 4 1/2".....	90
Operating Scissors Standard pattern, straight, Blunt/Blunt, 5 1/2".....	90
Operating Scissors Standard pattern, straight, Blunt/Blunt, 5 1/2", SC..	91
Operating Scissors Standard pattern, straight, Blunt/Blunt, 5".....	90
Operating Scissors Standard pattern, straight, Blunt/Blunt, 6 1/2".....	90
Operating Scissors Standard pattern, straight, Blunt/Blunt, 6".....	90
Operating Scissors Standard pattern, straight, Sharp/Blunt 4 1/2".....	89
Operating Scissors Standard pattern, Straight, Sharp/Blunt, 5 1/2".....	89
Operating Scissors Standard pattern, Straight, Sharp/Blunt, 5 1/2", SC..	91
Operating Scissors Standard pattern, straight, Sharp/Blunt, 5".....	89
Operating Scissors Standard pattern, straight, Sharp/Blunt, 7 1/2".....	89
Operating Scissors Standard pattern, straight, Sharp/Sharp, 6 1/2".....	88
Operating Scissors Standard pattern, straight, Sharp/Sharp, 6".....	88
Operating Scissors Standared pattern, straight, Sharp/Blunt 6 1/2".....	89
Operating Scissors, Curved Blunt/Blunt, 6 1/2".....	90
Operating Scissors, Curved, Blunt/Blunt, 6".....	90
Operating Scissors, Standard pattern, curved, Blunt/Blunt 5".....	90
Operating Scissors, Standard pattern, curved, Blunt/Blunt, 4 1/2".....	90
Operating Scissors, Standard pattern, curved, Blunt/Blunt, 5 1/2".....	90
Operating Scissors, Straight, Blunt/Blunt Tungsten Carbide 5 1/2".....	97
Operating Scissors, Straight, Sharp/Blunt Tungsten Carbide 5 1/2".....	97
Operating Scissors, Straight, Sharp/Sharp Tungsten Carbide 5 1/2".....	97
Operating Scissors,TC Insert,curved, blunt/blunt, 5 1/2".....	97
Operating Scissors,TC Insert,curved, sharp/blunt, 5 1/2".....	97
Operating Scissors,TC Insert,curved, sharp/sharp, 5 1/2".....	97
Orban Knife 1-2.....	20

P

Parallel Action Wire Cutters.....	64
Parallel Action Wire Cutters 4 1/2".....	64
Pedatric Balfour Abdominal Retractors With Fenestrated.....	81
Pedifine Allis Tissue Forceps, 4X5 Teeth, 4 3/4".....	27
Pedifine Allis Tissue Forceps, 4X5 Teeth, 5 3/4".....	27
Peers Towel Clamp, Non-Perforating, 5.5".....	37
Pin Cutter 19".....	58
Plain (Splinter) Forceps, 3 1/2".....	27
Plain (Splinter) Forceps, 4 1/2".....	27
Plain Wire Speculum, 15mm Wide Blades 2 1/2".....	53
Plate Bender Pliers.....	64
Poole Suction Tube 23 Fr.Curved.....	32
Poole Suction Tube 30 Fr.Straight.....	32
Potts-Smith Dressing Forceps, Serrated Jaw, 6".....	28
Potts-Smith Dressing Forceps, Serrated Jaw, 7".....	28
Potts-Smith Dressing Forceps, Serrated Jaw, 8 1/4".....	28
Potts-Smith Dressing Forceps, Serrated Jaw, 9 1/2".....	28
Potts-Smith Tissue Forceps, 1X2 Teeth, 6".....	28
Potts-Smith Tissue Forceps, 1X2 Teeth, 7".....	28
Potts-Smith Tissue Forceps, 1X2 Teeth, 8 1/4".....	28
Potts-Smith Tissue Forceps, 1X2 Teeth, 9 1/2".....	28
Probe 20-23 Explorer TT DE.....	13

Probe with Eye 10".....	78
Probe with Eye 12".....	78
Probe with Eye 4 1/2".....	78
Probe with Eye 5 1/2".....	78
Probe with Eye 5".....	78
Probe with Eye 6".....	78
Probe with Eye 8".....	78
Probe/Explorer, Double Ended, 3, 6, 9, & 12mm markings.....	79
Providence Hospital Hemostatic Forceps Curved 5 1/2".....	38
Providence Hospital Hemostatic Forceps Straight 5 1/2".....	38
Pynchon Suction Tube 10" tip with large opening.....	32
Pynchon Suction Tube 11" tip with large opening.....	32

Q

Quick Lock Tourniquet with 32" Neoprene cord.....	42
---	----

R

Ragnell Dissecting Scissors Flat tip Curved 7" SUPERCUT.....	88
Ragnell Dissecting Scissors Straight 5" Supercut.....	88
Ragnell Retractor 6" D/E.....	83
Rankin-Kelly Forceps Curved 6 1/4".....	38
Rankin-Kelly Forceps Straight 6 1/4".....	38
Ribbon Retractor, Malleable .75", 13".....	84
Ribbon Retractor, Malleable 1.0", 13".....	84
Ribbon Retractor, Malleable 1.25", 13".....	84
Ribbon Retractor, Malleable 1.5", 13".....	84
Ribbon Retractor, Malleable 2.0", 13".....	84
Ribbon Retractor, Malleable 2.5", 13".....	84
Ribbon Retractor, Malleable 3.0", 13".....	84
Rochester-Carmalt Forceps 6 1/4" Curved.....	38
Rochester-Carmalt Forceps 6 1/4" Straight.....	38
Rochester-Carmalt Forceps 8" Curved.....	38
Rochester-Carmalt Forceps 8" Straight.....	38
Rochester-Ochsner (Kocher) Forceps, Curved, 1x2 Teeth, 10".....	39
Rochester-Ochsner (Kocher) Forceps, Curved, 1x2 Teeth, 5 1/2".....	38
Rochester-Ochsner (Kocher) Forceps, Curved, 1x2 Teeth, 9".....	39
Rochester-Ochsner (Kocher) Forceps, Straight, 1x2 Teeth, 10".....	39
Rochester-Ochsner (Kocher) Forceps, Straight, 1x2 Teeth, 5 1/2".....	38
Rochester-Ochsner (Kocher) Forceps, Straight, 1x2 Teeth, 9".....	39
Rochester-Ochsner Forceps Curved 6 1/4" 1x2th.....	40
Rochester-Ochsner Forceps Curved 7 1/4" 1x2th.....	40
Rochester-Ochsner Forceps Curved 8" 1x2th.....	40
Rochester-Ochsner Forceps Straight 7 1/4" 1x2th.....	40
Rochester-Ochsner Forceps Straight 7 1/4" 1x2th.....	40
Rochester-Ochsner Forceps Straight 8" 1x2th.....	40
Rochester-Pean Forceps, Curved, 6 1/4".....	39
Rochester-Pean Forceps, Curved, 7 1/4".....	39
Rochester-Pean Forceps, Curved, 10".....	39
Rochester-Pean Forceps, Curved, 8".....	39
Rochester-Pean Forceps, Curved, 9".....	39
Rochester-Pean Forceps, Straight, 10".....	39
Rochester-Pean Forceps, Straight, 6 1/4".....	39
Rochester-Pean Forceps, Straight, 7 1/4".....	39
Rochester-Pean Forceps, Straight, 8".....	39
Rochester-Pean Forceps, Straight, 9".....	39
Roeder Towel Clamp 5 1/4".....	37
Roger Wire Cutting Scissors, Serrated Angular, 4 3/4".....	100
Roger Wire Cutting Scissors, Serrated Angular, 4 3/4",TC.....	100
Root Elevator, Crane Pick, DEL 34.....	5
Root Elevator, Crane Pick, DEL 34S.....	5
Root Elevator, Crane Pick, DEL46 Elevator.....	5
Root Elevators, Apical, DEL 301.....	5
Root Elevators, Apical, DEL 302HF.....	6
Root Elevators, DEL 78.....	6
Root Tip Elevator, Del 79, Curved Right, 5 1/2".....	6
Root Tip Elevator, Del 80, Curved Left, 5 1/2".....	6
Ruskin Bone Cutting Forceps Angled Jaw 7 1/4".....	65

Ruskin Bone Cutting Forceps Curved 6".....	65
Ruskin Bone Cutting Forceps Straight 6".....	65
Ruskin Bone Cutting Forceps Straight Jaw 7 1/4".....	65
Ruskin Rongeur 3x10mm Bite Curved 6".....	85
Ruskin Rongeur 4x15mm Bite Curved 7 1/4".....	85
Ruskin Rongeur 4x15mm Bite Straight 7 1/4".....	85
Ruskin-Liston Cutting Forceps, Angled, 7 1/2".....	65
Ruskin-Liston Cutting Forceps, Straight, 7 1/2".....	65
Russian Forceps, 10".....	62
Russian Forceps, 6".....	62
Russian Forceps, 8".....	62
Ryder (French Eye) Needle Holder, Tungsten Carbide, 5".....	49
Ryder (French Eye) Needle Holder, Tungsten Carbide, 6".....	49
Ryder (French Eye) Needle Holder, Tungsten Carbide, 7".....	49
Ryder (French Eye) Needle Holder, Tungsten Carbide, 8".....	49
Ryder (French Eye) Needle Holder, Tungsten Carbide, 9".....	49

S

Scaler, Jacquette H 6/7.....	18
Schiotz Tonometer.....	54
Schiotz Tonometer, Complete With Case.....	54
Scraper, Angular Point.....	14
Scraper, Curved, with Straight Edge.....	14
Scraper, Curved,With Angle Edge.....	14
Scraper, Double End,Curved,With Angled Edges.....	14
Screwdriver 20mm.....	62
Semken Tissue Forceps, 1X2 Teeth, Curved Tips, Size 5".....	28
Semken Tissue Forceps, 2X3 Teeth, Curved Tips, Size 5".....	28
Senn Retractor 3 Prongs Blunt 6 1/4".....	84
Senn Retractor 3 Prongs Sharp 6 1/4".....	84
Small Pin Hand, Chuck Vise.....	62
Small Stifle Retractor 5" With Speed Lock, Cross Action Tips.....	84
Smillie Knife 6 3/4" Straight.....	67
Snook Hook, Blunt, 8".....	67
Snook Hook, Blunt, 8" Solid Tip.....	67
Spay Pack with Olsen Hegar N.H.....	75
Spay Pack with Olsen Hegar N.H.TC Insert.....	76
Spencer Stitch Scissors 3 1/2".....	100
Spencer Stitch Scissors 3 1/2" Delicate.....	100
Spencer Stitch Scissors, 4 3/4".....	100
Stainless Steel, 18 Guage, Dia .040".....	110
Stainless Steel, 20 Guage, Dia .032".....	110
Stainless Steel, 24 Guage, Dia .020".....	110
Stainless Steel, 25 Guage, Dia .018".....	110
Stainless Steel, 26 Guage, Dia .016".....	110
Stainless Steel, 28 Guage,Dia .012".....	110
Stainless Steel, 30 Guage,Dia .010".....	110
Stainless Steel, 32 Guage,Dia .008".....	110
Stainless Steel, 34 Guage,Dia .006".....	110
Stainless Steel, 36 Guage,Dia .005".....	110
Stainless Steel, 38 Guage,Dia .004".....	110
Stainless Steel, 40 Guage,Dia .003".....	110
Standard Extracting Forceps #1.....	8
Standard Veterinary Eye Pack.....	76
Standard Veterinary Orthopedic Pack.....	77
Sterile Surgical Blade Beaver, Style 61, 12/Box.....	105
Sterile Surgical Blade Beaver, Style 62, 12/Box.....	105
Sterile Surgical Blade Beaver, Style 64, 12/Box.....	105
Sterile Surgical Blade Beaver, Style 67 Slim, 12/Box.....	105
Sterile Surgical Blade Beaver, Style 67, 12/Box.....	105
Sterile Surgical Blades, Box of 100, Carbon Steel Size 10.....	102
Sterile Surgical Blades, Box of 100, Carbon Steel Size 11.....	102
Sterile Surgical Blades, Box of 100, Carbon Steel Size 12.....	102
Sterile Surgical Blades, Box of 100, Carbon Steel Size 12B.....	102
Sterile Surgical Blades, Box of 100, Carbon Steel Size 15.....	102
Sterile Surgical Blades, Box of 100, Carbon Steel Size 15C.....	102
Sterile Surgical Blades, Box of 100, Carbon Steel Size 20.....	103
Sterile Surgical Blades, Box of 100, Carbon Steel Size 21.....	103
Sterile Surgical Blades, Box of 100, Carbon Steel Size 22.....	103

Sterile Surgical Blades, Box of 100, Stainless Steel, Size 23.....	105
Sterile Surgical Blades, Box of 100, Stainless Steel, Size 25.....	101
Sterile Surgical Blades, Box of 100, Stainless Steel, Size 11.....	103
Sterilizer, Needle, Spiral Rack	43
Sterilizing Case for schiötz tonometers 6 1/2". 3 1/2". 1 1/4".....	55
Stevens Tenotomy 4 1/2" Curved, Supercut	55
Stevens Tenotomy 4 1/2" Straight, Supercut	55
Stevens Tenotomy Curved 4 1/2".....	55
Stevens Tenotomy Scissors, Curved 4 1/4" Blunt Tips.....	55
Stevens Tenotomy Scissors, Curved 4 1/4" Blunt Tips, Slender.....	55
Stevens Tenotomy Scissors, Straight 4 1/4" Blunt Tips.....	55
Stevens Tenotomy Scissors, Straight 4 1/4" Blunt Tips, Slender.....	55
Stevens Tenotomy Straight 4 1/2".....	55
Stille Pattern Drill Set.....	68
Stille Pattern Vessel Clamp, 9".....	69
Stille-Luer Ronguer 8 1/2" 9x15mm Bite Curved.....	50
Stille-Luer Ronguer 8 1/2" 9x15mm Bite Straight.....	50
Stille-Luer Ronguer, Curved 8 3/4".....	50
Stille-Luer Ronguer, Curved Angled 9".....	50
Stitch Scissors Blunt Blades 3 3/4" Curved, Fine Tips.....	87
Strabismus Scissors,curved, 4 1/4"/ 11.5 cm.....	56
Strabismus Scissors,Straight, 4 1/4"/ 11.5 cm.....	56
Surgical Needle, 1/2 Circle Cutting Edge.....	107
Surgical Needle, 1/2 Circle Cutting Edge, but taper point.....	107
Surgical Needle, Circle Cutting Edge, Veterinary Heavy Pattern.....	106
Surgical Needle, Circle, Cutting Edge, Regular Eye.....	106
Surgical Needle, Double Curved Heavy Pattern, Cutting Edge.....	109
Surgical Needle, Half Circle Cutting Edge, Veterinary Heavy Pattern.....	107
Surgical Needle, Half Circle, Cutting Edge.....	107
Surgical Needle, Half Curved Heavy pattern, Cutting Edge.....	108
Surgical Needle, Half Curved,Cutting Edge, Regular.....	108
Surgical Needle, Regular Eye	108
Surgical Needle, Spring Eye.....	108
Surgical Needle, Spring Eye.....	109
Surgical Needle, With spring eye.....	109
Suture Scissors, Long, 6 1/4".....	100

T	
Tartar Scraper 5 3/4" Triangular Tip.....	14
Tartar Scraper D/E, Curved, Ang, style #12.....	15
Tartar Scraper, Claw Type.....	15
Taylor Percussion Hammer 7".....	33
Taylor Percussion Hammer 8".....	33
Thoms-Allis Tissue Forceps, 6X7 Teeth, 8".....	39
Thumb Dressing Forceps 10" Serrated.....	29
Thumb Dressing Forceps 12" Serrated.....	29
Thumb Dressing Forceps 6" Serrated.....	29
Thumb Dressing Forceps, Serrated Jaws, 4 1/2".....	29
Thumb Dressing Forceps, Serrated Jaws, 5".....	29
Thumb Dressing Forceps, Serrated Jaws, 5 1/2".....	29
Thumb Dressing Forceps, Serrated Jaws, 8".....	29
Thumb Tissue Forceps, 1x2 Teeth, 4 1/2".....	29
Thumb Tissue Forceps, 1x2 Teeth, 10".....	29
Thumb Tissue Forceps, 1x2 Teeth, 12".....	29
Thumb Tissue Forceps, 1x2 Teeth, 5 1/2".....	29
Thumb Tissue Forceps, 1x2 Teeth, 5".....	29
Thumb Tissue Forceps, 1x2 Teeth, 6".....	29
Thumb Tissue Forceps, 1x2 Teeth, 8".....	29
Thumb Tissue Forceps, 2x3 Teeth, 5 1/2".....	30
Thumb Tissue Forceps, 2x3 Teeth, 5".....	30
Thumb Tissue Forceps, 2x3 Teeth, 6".....	30
Thumb Tissue Forceps, 2x3 Teeth, 8".....	30
Thumb Tissue Forceps, 3x4 Teeth, 5 1/2".....	30
Thumb Tissue Forceps, 3x4 Teeth, 5".....	30
Thumb Tissue Forceps, 3x4 Teeth, 6".....	30
Tissue & Cuticle Nipper 4", Convex Jaws, Stainless.....	35
Tissue and Cuticle Nipper, 5", Convex Jaws, Stainless.....	35
Tissue and Cuticle Nipper, Convex Jaws, 4 1/2" Stainless.....	35
Trochlea Rasp 6 3/4".....	71

Troutman-Barraquer Colibri Utility Forceps, 3", 0.4mm.....	56
Troutman-Barraquer Colibri Utility Forceps, 3", 12mm.....	56
U.S. Army Pattern Osteotomes, 6 1/2", 6mm.....	60
U.S. Army Retractor, .625 Wide-Set of 2, 8.5".....	69
Universal Extracting Forceps 17S.....	11
Universal Extracting Forceps, 150S.....	11
Universal Extracting Forceps, 151S.....	11

V

Vannas After-Cataract Scissors, 3 1/8", Straight.....	15
Vannas Scissors, Angled on Flat, 3".....	15
Verbrugge Bone Holding Forceps, Large.....	65
Verbrugge Bone Holding Forceps, Small.....	65
Vet Advanced Eye Pack.....	74
Vet Advanced Eye Pack with Case.....	77
Vet Starter Eye Pack.....	75
Vet Starter Eye Pack with Case.....	77
"Veterinary Dental Set.....	78
Vienna Felina Vaginal Speculum, Large.....	101
Vienna Felina Vaginal Speculum, Medium.....	101
Vienna Felina Vaginal Speculum, Small.....	101
Volkman Bone Curette Size .0.....	33
Volkman Bone Curette Size 1.....	33
Volkman Bone Curette Size 2.....	33
Volkman Bone Curette Size 2/0.....	33
Volkman Bone Curette Size 3.....	33
Volkman Bone Curette Size 3/0.....	33
Volkman Bone Curette Size 4.....	33
Volkman Bone Curette Size 4/0.....	33
Volkman Bone Curette Size 5.....	33
Volkman Bone Curette Size 5/0.....	33
Volkman Bone Curette Size 6.....	33
Volkman Double Ended Curette, 5" 6 x10mm.....	33
Von Graefe Fixation Forceps, Spring, Non-magnetic, 4 3/8".....	28
Von Graefe Iris Forceps, 2 3/4" Curved, Delicate, 1x2 Teeth.....	56
Von Graefe Iris Forceps, serrated tips, curved, 2 3/4".....	56

W

Wallace Knee Retractor, 5".....	84
Webster Needle Holder, Smooth Jaws, 5".....	44
Weitlaner Retractor Sharp, 3x4th 6 1/2".....	80
Weitlaner Retractor 3x4th 6 1/2" Blunt.....	80
Weitlaner Retractor 5 1/2" Blunt 3x4 Prongs.....	80
Weitlaner Retractor 5 1/2" Sharp 3x4 Prongs.....	80
Weitlaner Retractor 8" Blunt 3x4 Prongs.....	80
Weitlaner Retractor 8" Sharp 3x4 Prongs.....	80
Weitlaner Retractor 9 1/2" Blunt 3x4 Prongs.....	80
Weitlaner Retractor 9 1/2" Sharp 3x4 Prongs.....	80
White Toe Nail Scissors 4 1/2".....	35
Winged Tip Elevator removeable handle, 2mm, 4 3/4".....	7
Winged Tip Elevator removeable handle, 3mm, 4 3/4".....	7
Winged Tip Elevator removeable handle, 4mm, 4 3/4".....	7
Winged Tip Elevator removeable handle, 5mm, 4 3/4".....	7
Winged Tip Elevator removeable handle, 6mm, 4 3/4".....	7
Winged Tip Elevator removeable handle, 7mm, 4 3/4".....	7
Winged Tip Elevator removeable handle, 8mm, 4 3/4".....	7
Wire Cutting Scissors 4 3/4" Angled, One Serrated Blade.....	100
Wire Cutting Scissors, Straight, 4 1/4".....	101
Wire Twister, Tungsten Carbide Insert Jaws, Size 6".....	59
Wire Twister, Tungsten Carbide Insert Jaws, Size 8".....	59
Wire twister/Shear Cutter.....	66

X

X-small serrated Bone Holding Forceps.....	66
--	----

Y

Yankauer Suction Tube 11 3/4" with removable tip.....	32
Yankauer Suction Tube, eplacement tip only.....	32
Young Tongue Forceps, Interchangeable jaw, 6 1/2".....	111

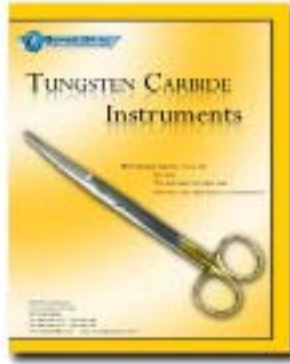

For Further information contact

GermedUSA Inc.

2417 Jericho Tpke #333,
Garden city park, New York 11040.
Tel : 516-358-2180 / 800-330-1322
Fax : 516-358-2182 / 800-260-7177
email : sales@germedusa.com
or
Visit us at www.germedusa.com



Download Catalogs at www.GermedUSA.com